



# Thermal Design Guide for Socket F (1207) Processors

Publication # <b>32800</b>	Revision: <b>3.00</b>
Issue Date: <b>August 2006</b>	

© 2005 Advanced Micro Devices, Inc. All rights reserved.

The contents of this document are provided in connection with Advanced Micro Devices, Inc. (“AMD”) products. AMD makes no representations or warranties with respect to the accuracy or completeness of the contents of this publication and reserves the right to make changes to specifications and product descriptions at any time without notice. The information contained herein may be of a preliminary or advance nature and is subject to change without notice. No license, whether express, implied, arising by estoppel or otherwise, to any intellectual property rights is granted by this publication. Except as set forth in AMD’s Standard Terms and Conditions of Sale, AMD assumes no liability whatsoever, and disclaims any express or implied warranty, relating to its products including, but not limited to, the implied warranty of merchantability, fitness for a particular purpose, or infringement of any intellectual property right.

AMD’s products are not designed, intended, authorized or warranted for use as components in systems intended for surgical implant into the body, or in other applications intended to support or sustain life, or in any other application in which the failure of AMD’s product could create a situation where personal injury, death, or severe property or environmental damage may occur. AMD reserves the right to discontinue or make changes to its products at any time without notice.

#### **Trademarks**

AMD, the AMD Arrow logo, and combinations thereof, are trademarks of Advanced Micro Devices, Inc.

Other product names used in this publication are for identification purposes only and may be trademarks of their respective companies.

# Contents

---

<b>Revision History</b> .....	<b>.9</b>
<b>Chapter 1 Introduction</b> .....	<b>.11</b>
1.1 Summary of Requirements .....	11
<b>Chapter 2 Processor Thermal Solutions</b> .....	<b>.13</b>
2.1 Processor Specifications .....	13
2.2 Socket Description .....	14
<b>Chapter 3 Thermal Design of Platforms Using the AMD Processor-In-a-Box (PIB) Thermal Solution</b> .....	<b>.15</b>
3.1 Motherboard Component Height Restrictions .....	15
3.2 Thermal Solution Design Requirements .....	16
3.3 Sample Heat Sinks and Attachment Methods .....	16
3.3.1 Backplate Assembly .....	18
3.3.2 Retention Frame .....	19
<b>Chapter 4 Thermal Design of Custom 1U-2P Systems</b> .....	<b>.21</b>
4.1 Motherboard Component Height Restrictions .....	21
4.2 Thermal Solution Design Requirements .....	22
4.3 Sample Heat Sinks and Attachment Methods .....	22
4.3.1 Backplate Assembly .....	24
4.3.2 Spring Screws .....	24
4.3.3 Heat Sink .....	25
4.3.4 Fans .....	26
4.3.5 Thermal Interface Material .....	27
<b>Chapter 5 Thermal Design of Custom 2U-4P Systems</b> .....	<b>.29</b>
5.1 Motherboard Component Height Restrictions .....	29
5.2 Thermal Solution Design Requirements .....	30
5.3 Sample Heat Sinks and Attachment Methods .....	30
5.3.1 Backplate Assembly .....	32
5.3.2 Spring Clip .....	33
5.3.3 Retention Frame .....	33

5.3.4	Heat Sink .....	33
5.3.5	Fans .....	35
5.3.6	Thermal Interface Material .....	35
<b>Appendix A</b>	<b>Keep-Out Drawings for Platforms Using the PIB Thermal Solution for Socket F (1207) Processors .....</b>	<b>37</b>
<b>Appendix B</b>	<b>Keep-Out Drawings for Custom 1U-2P Systems Based on the Socket F (1207) Processor .....</b>	<b>45</b>
<b>Appendix C</b>	<b>Keep-Out Drawings for Custom 2U-4P Systems Based on the Socket F (1207) Processor .....</b>	<b>53</b>
<b>Appendix D</b>	<b>Flow Simulation Results for Custom 2U-4P Systems Based on Socket F (1207) Processors .....</b>	<b>61</b>

## List of Figures

---

Figure 1.	The 1207-Pin Socket. . . . .	14
Figure 2.	Motherboard Component Height Restrictions for Platforms Using the AMD PIB Thermal Solution. . . . .	15
Figure 3.	Exploded View of Thermal Solution AMD PIB Platforms based on Socket F (1207) Processors. . . . .	18
Figure 4.	Motherboard Component Height Restrictions for Custom 1U-2P Systems. . . . .	21
Figure 5.	Exploded View of Thermal Solution for Custom 1U-2P Systems. . . . .	24
Figure 6.	High Performance Heat Sink for Custom 1U-2P Systems. . . . .	25
Figure 7.	Thermal Performance Chart of Heat Sink When Used with a Dual-Core Processor in 90 nm Process. . . . .	26
Figure 8.	Motherboard Component-Height Restrictions for Custom 2U-4P Systems. . . . .	29
Figure 9.	Exploded View of Thermal Solution for Custom 2U-4P System Based on Socket F (1207) Processors <sup>32</sup> . . . . .	
Figure 10.	High Performance Heat Sink for Custom 2U-4P Systems. . . . .	34
Figure 11.	Thermal Performance Chart of Heat Sink When Used with a Dual-Core Processor in 90 nm Process. . . . .	35
Figure 12.	Socket F (1207) PIB Board Component Height Restrictions. . . . .	38
Figure 13.	Socket F (1207) PIB Mounting Holes, Contact Pads, and No-Routing Zone. . . . .	39
Figure 14.	Socket F (1207) PIB Socket Outline and Socket Window. . . . .	40
Figure 15.	Socket F (1207) PIB Heat Sink Height Restriction Zone. . . . .	41
Figure 16.	Socket F (1207) PIB Board No-Through-Hole Keep-Out. . . . .	42
Figure 17.	Socket F (1207) PIB Board Bottom Side Keep-Out. . . . .	43
Figure 18.	Socket F (1207) 1U-2P Board Component Height Restrictions. . . . .	46
Figure 19.	Socket F (1207) 1U-2P Mounting Holes, Contact Pads, and No-Routing Zone. . . . .	47
Figure 20.	Socket F (1207) 1U-2P Socket Outline and Socket Window. . . . .	48
Figure 21.	Socket F (1207) 1U-2P Heat Sink Height Restriction Zone. . . . .	49
Figure 22.	Socket F (1207) 1U-2P Board No-Through-Hole Keep-Out. . . . .	50
Figure 23.	Socket F (1207) 1U-2P Backplate Contact Zone. . . . .	51
Figure 24.	Socket F (1207) 2U-4P Board Component Height Restrictions. . . . .	54
Figure 25.	Socket F (1207) 2U-4P Mounting Holes, Contact Pads, and No-Routing Zone. . . . .	55

Figure 26.	Socket F (1207) 2U-4P Socket Outline and Socket Window . . . . .	56
Figure 27.	Socket F (1207) 2U-4P Heat Sink Height Restriction Zone. . . . .	57
Figure 28.	Socket F (1207) 2U-4P Board No-Through-Hole Keep-Out . . . . .	58
Figure 29.	Socket F (1207) 2U-4P Backplate Contact Zone . . . . .	59
Figure 30.	Floor-Plan of AMD Reference Custom 2U-4P System . . . . .	61
Figure 31.	Streamline Plot of AMD Reference Custom 2U-4P System . . . . .	62

## List of Tables

---

Table 1.	Mechanical and Thermal Specifications for Socket F (1207) Processors. . . . .	13
Table 2.	Thermal Solution Design Requirements for Platforms Using Socket F (1207) PIB processors . . . . .	16
Table 3.	Components for the Processor Thermal Reference Design for the AMD PIB Thermal Solution . . . . .	17
Table 4.	Thermal Solution Design Requirements for Custom 1U-2P Systems . . . . .	22
Table 5.	Components for the Processor Thermal Reference Design for Custom 1U-2P Systems . . . . .	23
Table 6.	Fin Parameters. . . . .	25
Table 7.	Thermal Solution Design Requirements for Custom 2U-4P Systems . . . . .	30
Table 8.	Components for the Processor Thermal Reference Design for Custom 2U-4P Systems . . . . .	31
Table 9.	Chemical Element of SK7 Spring Steel . . . . .	33
Table 10.	Fin Parameters. . . . .	34





## Revision History

---

<b>Date</b>	<b>Revision</b>	<b>Description</b>
July 2006	3.00	Initial Public release.



---

# Chapter 1 Introduction

---

This document specifies performance requirements for the design of thermal and mechanical solutions for socket F (1207) processors, utilizing AMD 64-bit technology. Detailed drawings, descriptions, and design targets are provided to help manufacturers, vendors, and engineers meet the requirements for the socket F (1207) processors.

## 1.1 Summary of Requirements

To allow optimal reliability of a processor, the thermal and cooling solution dissipates heat from that processor operating at the thermal design power. This document specifies the required values for the thermal and mechanical parameters of systems based on socket F (1207) processors.



## Chapter 2 Processor Thermal Solutions

This chapter describes the thermal solutions for systems based on socket F (1207) processors.

### 2.1 Processor Specifications

The objective of thermal solutions is to maintain the processor temperature within specified limits. Thermal performance, physical mounting, acoustic noise, mass, reliability, and cost must be considered during the design of a thermal solution.

Table 1 lists the pertinent processor specifications for a thermal solution design for systems based on socket F (1207) processors.

**Table 1. Mechanical and Thermal Specifications for Socket F (1207) Processors**

Symbol	Description	Maximum Value	Notes
T <sub>Case</sub>	Maximum case temperature	67°C - 72°C	Consult the processor data sheet for the thermal requirements specific to the processor.
A <sub>CPU</sub>	Processor contact area	32.5 mm x 32.5 mm	Interfaces with heat sink
Form Factor	Processor form factor	LGA	LGA form factor for socket F (1207) processors

## 2.2 Socket Description

Figure 1 shows a three-dimensional view of the 1207-pin socket used with socket F (1207) processors. This socket is based on LGA (land-grid array) technology. The LGA socket has 35 pads x 35 pads on a 1.1 mm pitch, with a 3.52 mm wide de-populated BGA (ball grid array) zone in the center, plus a 0.66 mm offset between the two BGA arrays. A small solder-ball makes the electrical and mechanical connection to the motherboard at each socket contact.

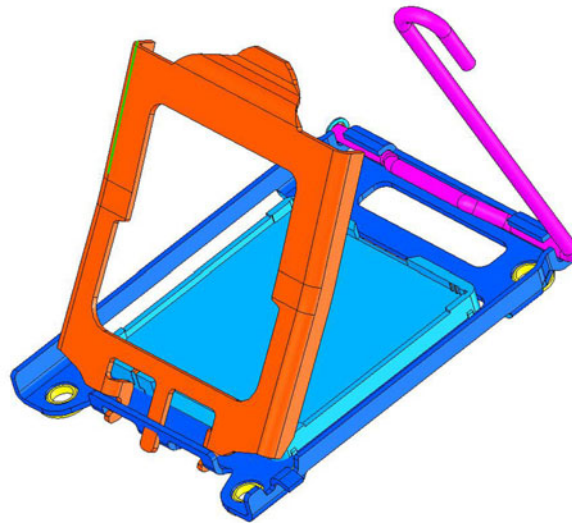

**Figure 1.** The 1207-Pin Socket

## Chapter 3 Thermal Design of Platforms Using the AMD Processor-In-a-Box (PIB) Thermal Solution

This chapter describes the motherboard component height restrictions, thermal-solution design requirements, sample heat sinks, and attachment methods for platforms using the AMD Processor-In-a-Box (PIB) thermal solution for socket F (1207) processors.

### 3.1 Motherboard Component Height Restrictions

The mounting solution for the heat sink calls for a standard motherboard keep-out region and mounting holes for the processor. Figure 2 shows an overview of the motherboard component height restrictions for platforms using the PIB thermal solution for socket F (1207) processors.

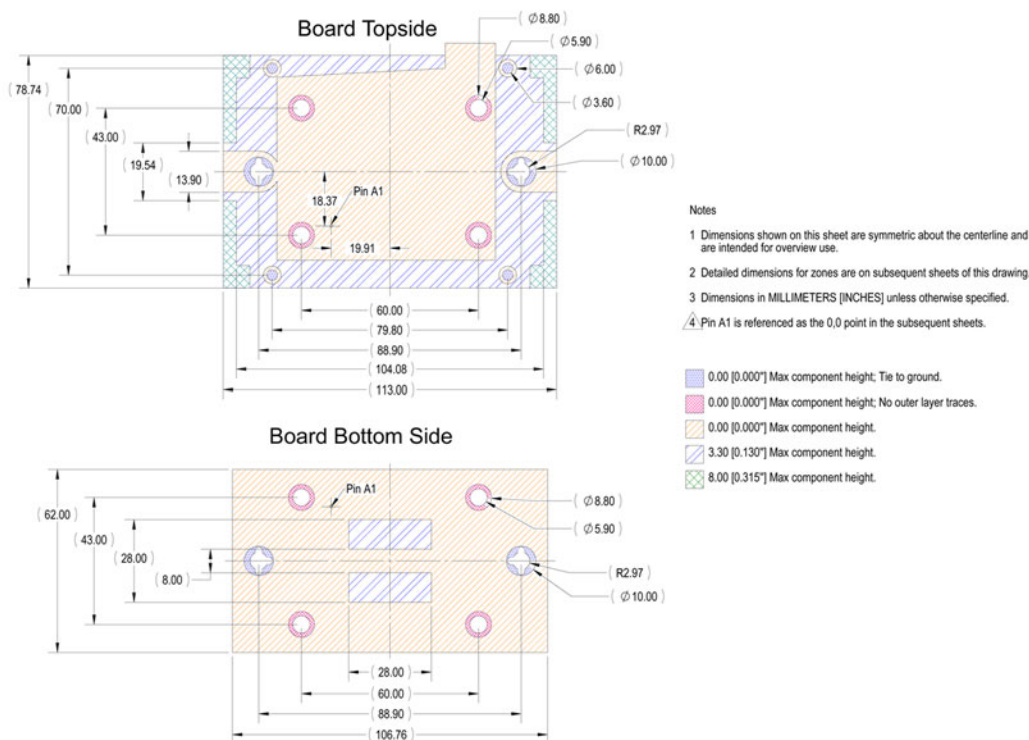

**Figure 2. Motherboard Component Height Restrictions for Platforms Using the AMD PIB Thermal Solution**

Depending on the system features and layout, more space around the socket may be available for the thermal solution than is shown in Figure 2 on page 15. This space permits heat sink designs with better thermal performance.

Appendix A on page 37 shows a complete, detailed set of keep-out drawings for the AMD PIB thermal solution for socket F (1207).

## 3.2 Thermal Solution Design Requirements

Table 2 provides the design-target specifications that must be met for the processor to operate reliably in a typical platform using the AMD PIB thermal solution for socket F (1207) processors.

**Table 2. Thermal Solution Design Requirements for Platforms Using Socket F (1207) PIB processors**

Symbol	Description	Maximum
L	Length of heat sink	68 mm
W	Width of heat sink	77 mm
H	Height of heat sink	60 mm
$\theta_{ca}$	Case-to-ambient thermal resistance	0.26°C/W <sup>1</sup>
$M_{HS}$	Mass of heat sink	450 g to 700 g <sup>2</sup>
$F_{clip}$	Clip force	75 lbs ±15 lbs
$T_A$	Local ambient temperature near processor	38°C

**Notes:**

1. This is the thermal resistance required for dual-core, 90-nm socket F (1207) processors. The thermal resistance requirement may vary depending on the product OPN. The user should consult the processor data sheet for the thermal requirements specific to the part.
2. Heat sinks weighing up to 450 g can be attached to the motherboard. Heat sinks weighing over 450 g should be tied directly to the chassis for reliable shock and vibration performance.

## 3.3 Sample Heat Sinks and Attachment Methods

The heat sink, fan, mounting spring clip, and thermal interface material used for the AMD PIB thermal solution for socket F (1207) processors are the same as the heat sink, fan, mounting spring clip, and thermal interface material used for systems based on the socket 940 processor.

The backplate and retention frame are different from those used in the socket 940 processor. The EMC shield implemented in the socket 940-based systems is not recommended for AMD PIB thermal solutions for socket F (1207) processors.

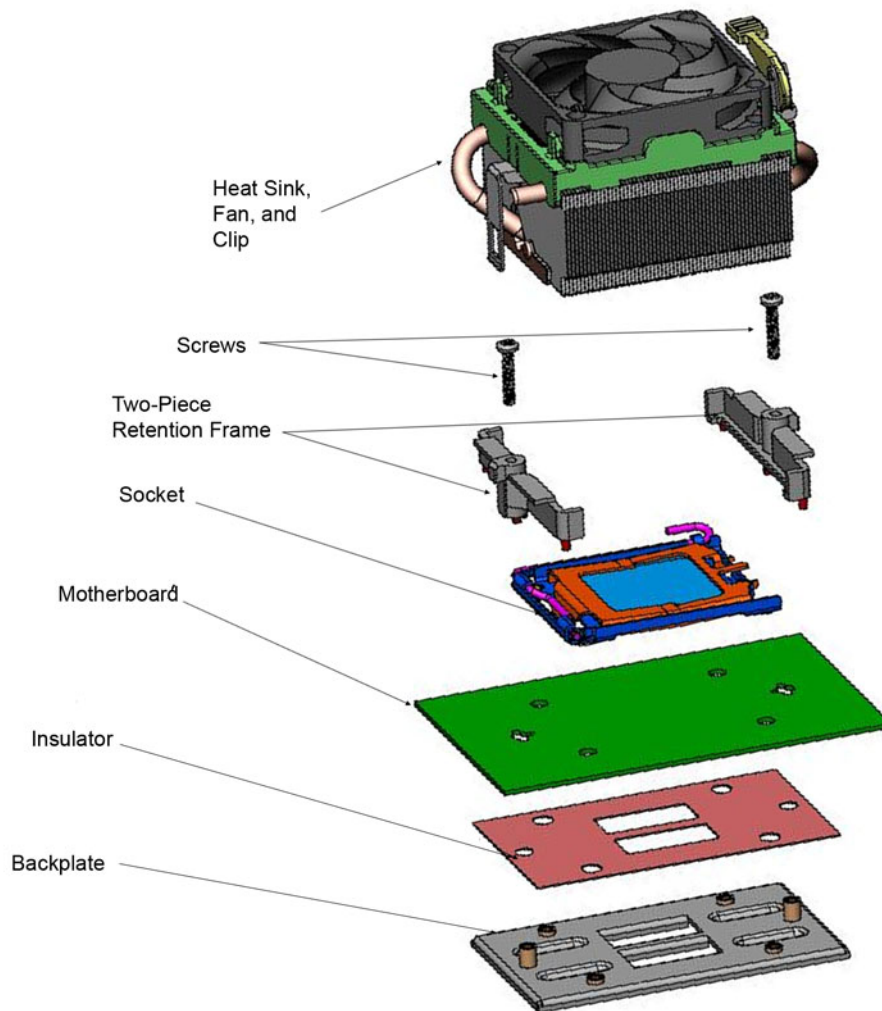

Table 3 lists the parts used in the thermal reference design for the AMD PIB thermal solution for socket F (1207) processors.

**Table 3. Components for the Processor Thermal Reference Design for the AMD PIB Thermal Solution**

<b>Part Description</b>	<b>Material</b>	<b>Quantity</b>
Heat sink	Copper with aluminum fins	1
Heatpipe	Sintered-powder copper	2
Fan	Plastic	1
Spring clip	SK7 heat treated spring steel	1
Retention frame	Lexan, 20% glass-filled	2
Backplate	Low-carbon steel, anti-corrosive finish	1
Insulator	Formex GK-17	1

Figure 3 on page 18 shows an exploded view of the thermal solution for platforms using an AMD PIB based on socket F (1207) processors.



**Figure 3. Exploded View of Thermal Solution AMD PIB Platforms based on Socket F (1207) Processors**

### 3.3.1 Backplate Assembly

The backplate is mounted on the backside of the motherboard and enhances local stiffness to support shock and vibration loads acting on the heat sink. The backplate assembly prevents excessive motherboard warpage in the area near the processor. Without a backplate, excessive warpage could cause serious damage to electrical connections of the processor socket and integrated circuit packages surrounding the processor. The backplate also serves as a stiffener plate for the LGA socket.

The reference backplate is made from a 1/16-inch, hard-milled steel, has an overall thickness of 0.138 inch (3.5 mm), including stiffening ribs, and has a mounting-hole pitch of 3.5 inches. To accommodate the capacitors on the backside of the board, there is a square hole in the center of the backplate.

**Note:** *Do not cut entirely through the center rib. Doing so will compromise the stiffness of the backplate.*

The plate uses two PennEngineering (PEM) standoffs that serve multiple purposes. The PEM standoffs serve as attachment points for the retention frame screws. They also align the backplate properly to the motherboard. Features in the retention frame slide over the standoffs and allow the installation of the screws with a minimum chance of cross threading. Additionally, four M3.5 PEM standoffs in the backplate serve as attachment points for the socket.

The insulator prevents the backplate from electrically shorting to the motherboard. A pressure-sensitive adhesive in the insulator keeps the backplate in place against the motherboard during assembly. The insulator also is thick enough to prevent any significant capacitive coupling between the motherboard and backplate.

### **3.3.2 Retention Frame**

The plastic retention frame, made of 20% glass-filled Lexan, is a two-piece implementation rather than the single-piece frame used for socket 940. This change accommodates the larger foot-print of socket F (1207) processors.

The retention frame serves multiple purposes. The retention frame aligns the heat sink and provides a stop for the heat sink in large shock-force events. The retention frame and backplate are attached to the motherboard by the motherboard vendor. Two screws securely hold the backplate and retention frame together. The two mounting tabs on the retention frame serve as attachment points for the heat sink spring clip.



## Chapter 4 Thermal Design of Custom 1U-2P Systems

This chapter describes the motherboard component-height restrictions, thermal-solution design requirements, sample heat sinks, and attachment methods for custom 1U-2P systems based on socket F (1207) processors.

**Note:** *These keep-outs are defined for custom rack mount equipment to optimize thermal and acoustic performance in these systems. These keep-outs are not compliant with AMD Processor-In-a-Box (PIB) thermal solutions.*

### 4.1 Motherboard Component Height Restrictions

The mounting solution for the heat sink calls for a standard motherboard keep-out region and mounting holes for the processor. Figure 4 shows an overview of the motherboard component height restrictions for custom 1U-2P systems based on the thermal solution for socket F (1207) processors.

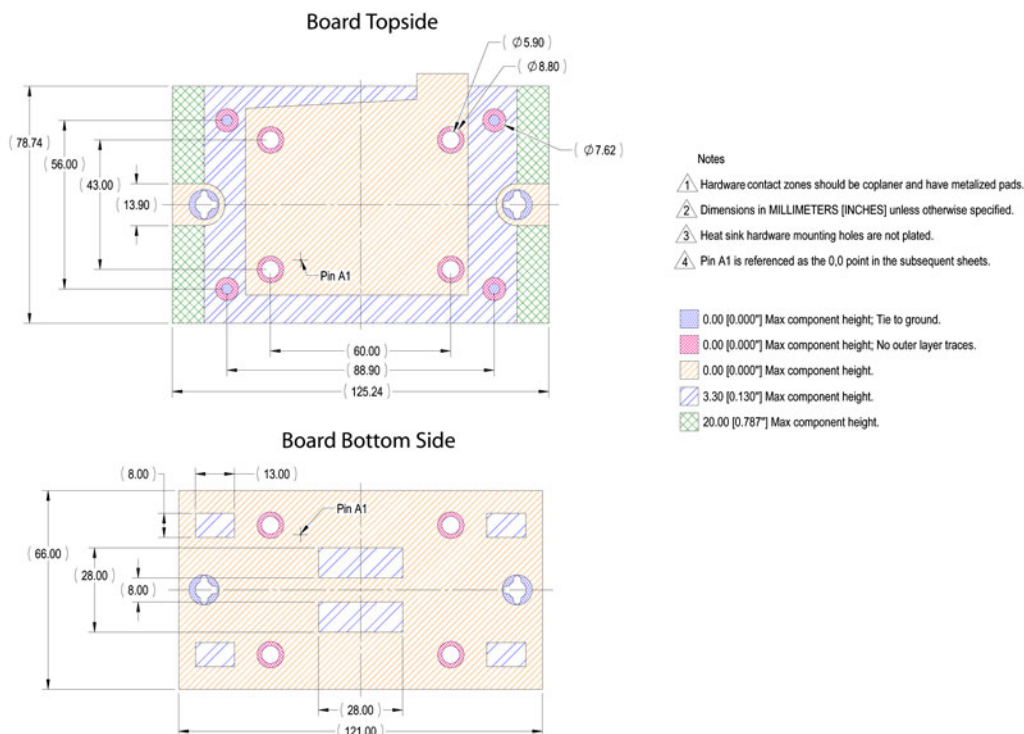

Figure 4. Motherboard Component Height Restrictions for Custom 1U-2P Systems

Depending on the system features and layout, more space around the socket may be available for the thermal solution than is shown in Figure 4 on page 21. This space permits heat sink designs with better thermal performance.

Appendix B on page 45 shows a complete, detailed set of keep-out drawings for custom 1U-2P systems based on socket F (1207) processors.

## 4.2 Thermal Solution Design Requirements

To maintain the case temperature of the processor below the maximum specification, certain heat sink design parameters must be considered. Table 4 provides the design-target specifications that must be met for socket F (1207) processors to operate reliably.

**Table 4. Thermal Solution Design Requirements for Custom 1U-2P Systems**

Symbol	Description	Maximum
L	Length of heat sink	87 mm
W	Width of heat sink	74 mm
H	Height of heat sink	28 mm
$\theta_{ca}$	Case-to-ambient thermal resistance	0.26°C/W <sup>1, 2, 3</sup>
$M_{HS}$	Mass of heat sink	450 g to 700 g
$F_{clip}$	Clip force	75 lbs ±15 lbs
$T_A$	Local air temperature entering processor heat sink	38°C

**Notes:**

1. This is the thermal resistance required for dual core, 90-nm socket F (1207) processors. The thermal resistance requirement may vary depending on the product OPN. The user should consult the processor data sheet for the thermal requirements specific to the part.
2. Heat sinks weighing up to 450 g can be attached to the motherboard. Heat sinks weighing over 450 g should be tied directly to the chassis for more reliable shock and vibration performance.
3. This chapter describes a heat sink weighing less than or equal to 450 g.

## 4.3 Sample Heat Sinks and Attachment Methods

The following sections provide one possible thermal design solution and the specifics on attaching that solution to the motherboard.

Table 5 on page 23 lists the parts used in the thermal reference design solution for 1U-2P systems based on socket F (1207) processors.

**Table 5. Components for the Processor Thermal Reference Design for Custom 1U-2P Systems**

<b>Part Description</b>	<b>Material</b>	<b>Quantity</b>
Heat sink	Copper base, aluminum fins	1
Fan	Plastic	1
Spring screw	SK7 heat treated spring steel	2
Backplate	Low carbon steel, anti-corrosive finish	1
Insulator	Formex GK-17	1

Figure 5 on page 24 shows an exploded view of the components used in the thermal reference design solution for custom 1U-2P systems based on socket F (1207) processors.

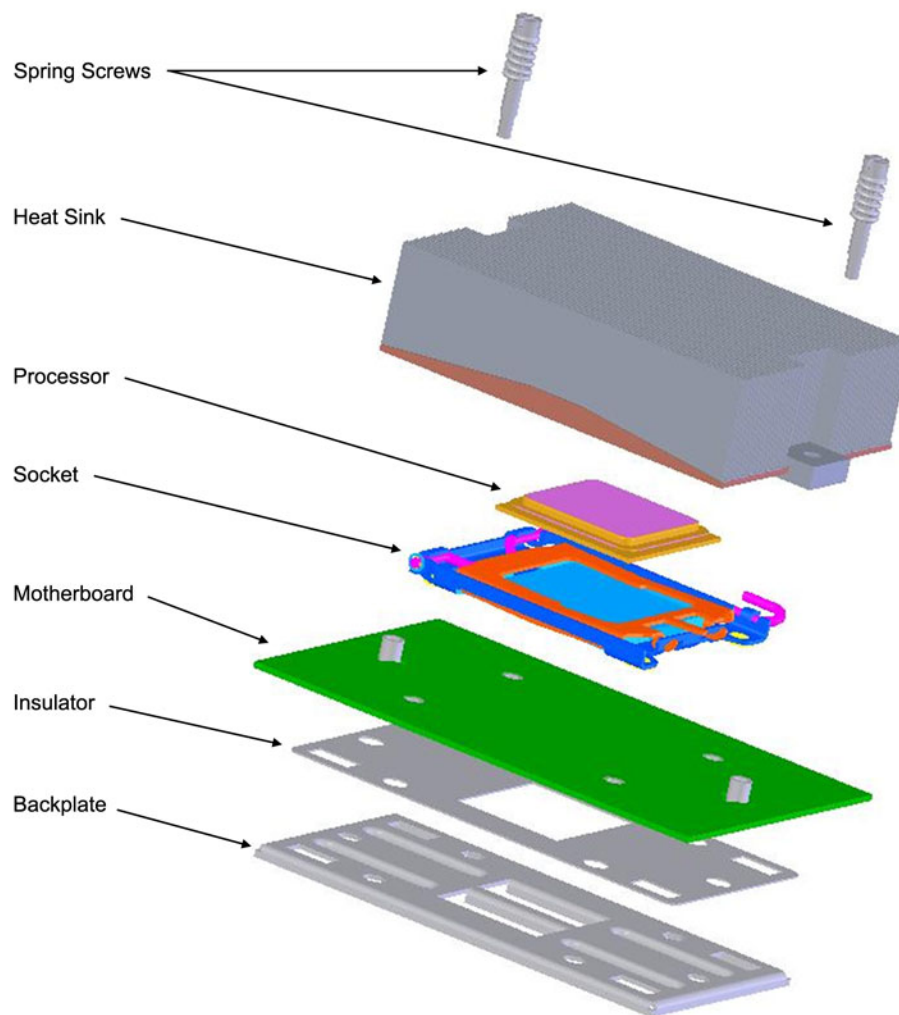

**Figure 5. Exploded View of Thermal Solution for Custom 1U-2P Systems**

The following sections describe the mechanical requirements of the components shown in Figure 5.

### 4.3.1 Backplate Assembly

For details on the backplate assembly, see section 3.3.1 on page 18.

*Note:* The backplate for this custom design has a mounting-hole pitch of 4.1 inches.

### 4.3.2 Spring Screws

The spring screws are designed to apply 75 lbs of force to the heat sink. This force is necessary to help prevent the heat sink from lifting off the package during shock- or vibration-induced events.



Lifting the heat sink away from the processor can result in damage to the processor contact pads, the socket contacts, or the socket solder-ball joints. Maintaining the spring force is important for the life of the processor and the socket and for repeated installations and upgrades of the processor.

### 4.3.3 Heat Sink

Figure 6 shows a picture of the reference design heat sink for 1U-2P systems. The footprint of the heat sink is 87 mm x 74 mm. The heat sink weighs 420 g and has aluminum fins soldered to a copper base. The copper base tapers from a thickness of 6 mm at the center to 1.5 mm at the edges. This tapering provides optimum heat-spreading performance from the processor to the heat sink while keeping the heat sink weight within specification. The fin geometry is designed to provide optimized thermal performance in combination with the fans, as described in Section 4.3.4, on page 26, in a typical 1U-2P system.

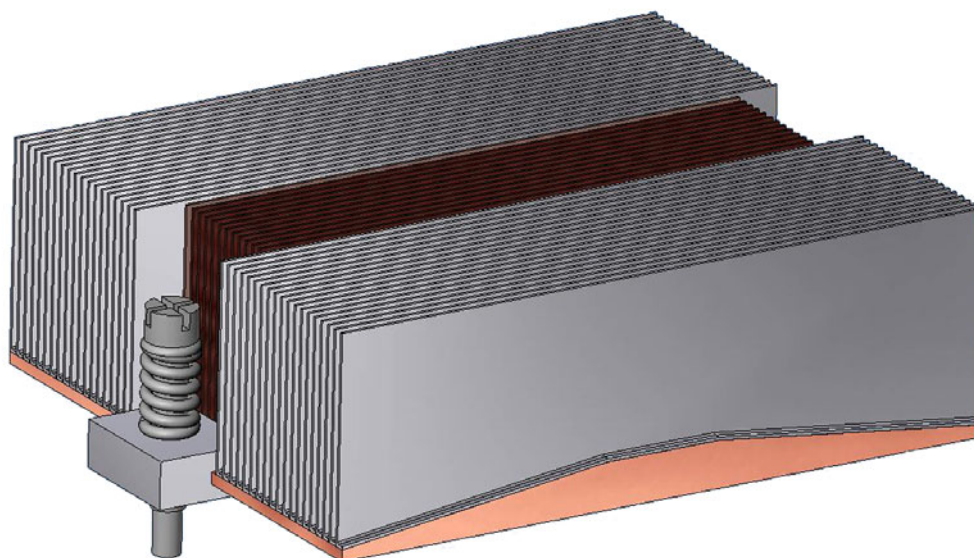

**Figure 6. High Performance Heat Sink for Custom 1U-2P Systems**

Table 6 shows the parameters of the aluminum fins for the high-performance heat sink shown in Figure 6.

**Table 6. Fin Parameters**

Length	Height (at Center)	Height (at Edges)	Thickness	Pitch	No. of Fins
87 mm	22 mm	26.5 mm	0.4 mm	1.48 mm	50

Other fan and heat sink combinations may yield adequate thermal performance. The system designer must ensure that the thermal solution provides required cooling for the processor for the given system layout and flow characteristics.

Because the processor-mounting surface extends above the surface of the cam box on the socket, the heat sink bottom can be flat. The heat sink must have a flat surface of at least 40 mm x 40 mm, centered over the processor.

Figure 7 shows the measured thermal performance vs. flow rate for a slightly shorter version of this heat sink (3.5" hole pitch vs. 4.1" hole pitch). This data represents the expected performance of this heat sink on a dual-core socket F (1207) processor. Based on flow tests on the AMD reference 1U-2P system, the flow through the heat sink is estimated to be approximately 20 cubic feet per minute (CFM). Figure 7 shows that this corresponds to case-to-ambient thermal resistance of  $0.24^{\circ}\text{C}/\text{W}$ . This case-to-ambient thermal resistance has been confirmed through system thermal tests. The requirement (see Table 4 on page 22) is  $0.26^{\circ}\text{C}/\text{W}$ .

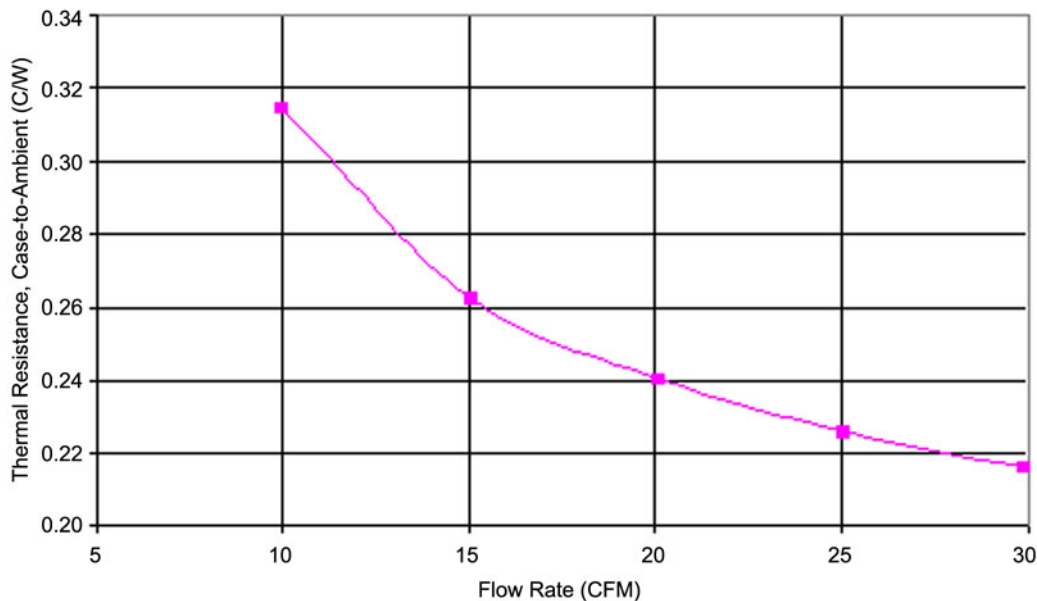

**Figure 7. Thermal Performance Chart of Heat Sink When Used with a Dual-Core Processor in 90 nm Process**

#### 4.3.4 Fans

AMD has tested the heat sink described in Section 4.3 on page 22 with a row of five 40 mm x 50 mm x 56 mm fans (Delta Part number GFB0412EHS) in a typical 1U-2P system. The fan has a 27.3-CFM maximum flow rate and a 1.63-inches water maximum pressure head. The heat sinks are ducted so the flow from two fans enters each of the processor heat sinks.

### **4.3.5 Thermal Interface Material**

The heat sink contacts the top surface of the processor package and utilizes the thermal interface material between the processor lid and the heat sink. AMD recommends using a high performance grease such as Shin-Etsu 7783D or Dow Corning TC-5022. AMD does not recommend using phase change materials between the heat sink and the processor. Phase-change materials develop high adhesion forces between the heat sink and processor when the material is in the solid phase. This strong adhesive force can cause the processor to stick to the heat sink, making heat sink removal difficult and damaging the socket solder balls.



## Chapter 5 Thermal Design of Custom 2U-4P Systems

This chapter describes the motherboard component-height restrictions, thermal-solution design requirements, sample heat sinks, and attachment methods for custom 2U-4P systems based on socket F (1207) processors.

**Note:** *These keep-outs are defined for custom rack mount equipment to optimize thermal and acoustic performance in these systems. These keep-outs are not compliant with AMD Processor-In-a-Box (PIB) thermal solutions.*

### 5.1 Motherboard Component Height Restrictions

The mounting solution for the heat sink calls for a standard motherboard keep-out region and mounting holes for the processor. Figure 8 shows an overview of the motherboard component height restrictions for custom 2U-4P systems based on the thermal solution for socket F (1207) processors.

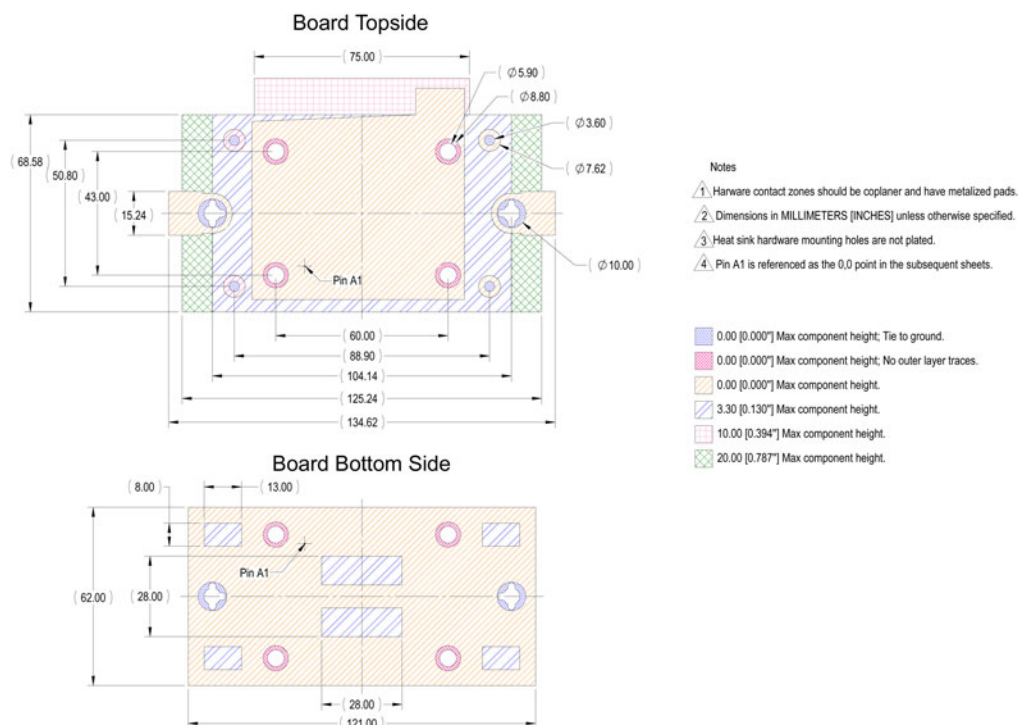

**Figure 8. Motherboard Component-Height Restrictions for Custom 2U-4P Systems**

Depending on the system features and layout, more space around the socket may be available for the thermal solution than is shown in Figure 8 on page 29. This space permits heat sink designs with better thermal performance.

Appendix C on page 53 shows a complete, detailed set of keep-out drawings for custom 2U-4P systems based on socket F (1207) processors.

## 5.2 Thermal Solution Design Requirements

Table 7 provides the design-target specifications that must be met for socket F (1207) processors to operate reliably in a typical 2U-4P system based on socket F (1207) processors.

**Table 7. Thermal Solution Design Requirements for Custom 2U-4P Systems**

Symbol	Description	Maximum
L	Length of heat sink	92 mm
W	Width of heat sink	58 mm
H	Height of heat sink	40 mm
$\theta_{ca}$	Case-to-ambient thermal resistance	0.26°C/W <sup>1, 2, 3</sup>
$M_{HS}$	Mass of heat sink	450 g to 700 g
$F_{clip}$	Clip force	75 lbs ±15 lbs
$T_A$	Local ambient temperature near processor	38°C

**Notes:**

1. This is the thermal resistance required for dual-core, 90-nm socket F (1207) processors. The thermal resistance requirement may vary depending on the product OPN. The user should consult the processor data sheet for the thermal requirements specific to the part.
2. Heat sinks weighing up to 450 g can be attached to the motherboard. Heat sinks weighing over 450 g should be tied directly to the chassis for more reliable shock and vibration performance.
3. This chapter describes a heat sink weighing less than or equal to 450 g. Design examples of solutions up to 700 g are in development.

## 5.3 Sample Heat Sinks and Attachment Methods

The following sections provide one possible thermal design solution and the specifics on attaching that solution to the motherboard.

Table 8 on page 31 lists the parts used in the thermal reference design for Custom 2U-4P systems based on socket F (1207) processors.

**Table 8. Components for the Processor Thermal Reference Design for Custom 2U-4P Systems**

<b>Part Description</b>	<b>Material</b>	<b>Quantity</b>
Heat sink	Aluminum	1
Fan	Plastic	1
Spring clip	SK7 heat treated spring steel	1
Retention frame	Lexan, 20% glass-filled	2
Backplate	Low carbon steel, anti-corrosive finish	1
Insulator	Formex GK-17	1

Figure 9 on page 32 shows an exploded view of the components used in the thermal reference design solution for custom 2U-4P systems based on socket F (1207) processors.

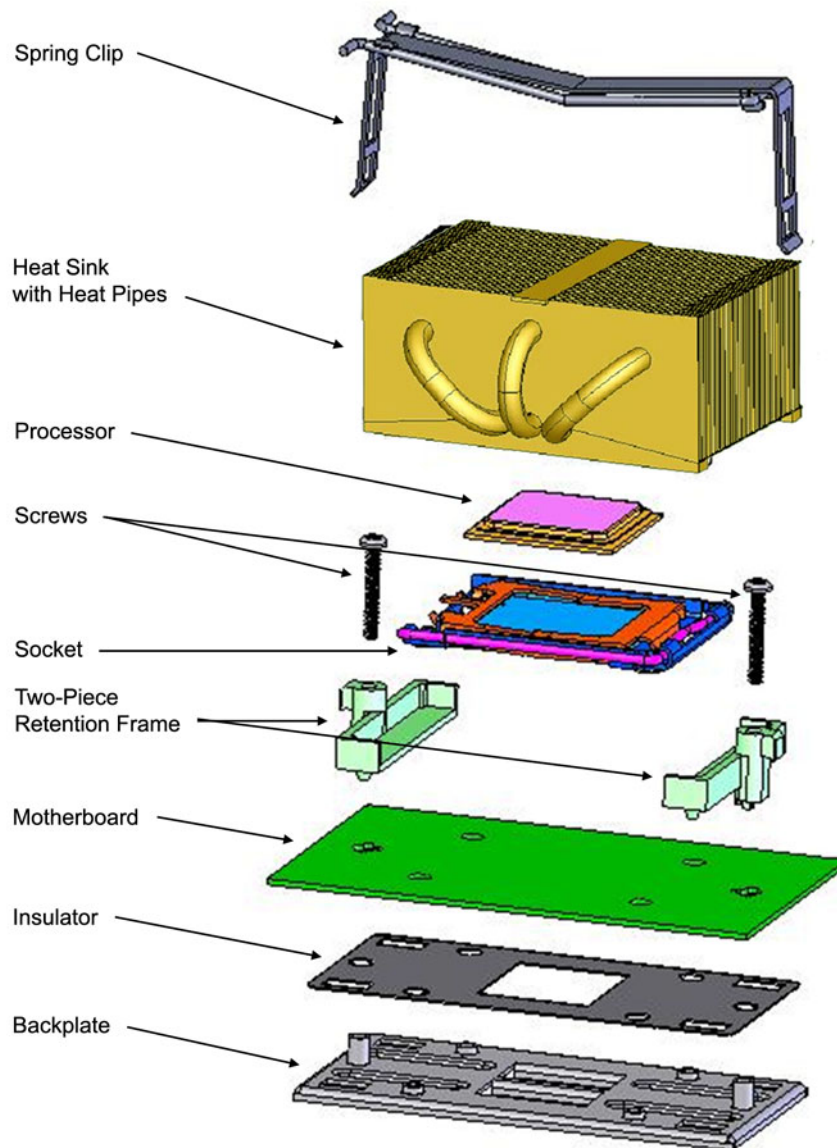

**Figure 9. Exploded View of Thermal Solution for Custom 2U-4P System Based on Socket F (1207) Processors**

The following sections describe the mechanical requirements of the components shown in Figure 9.

### 5.3.1 Backplate Assembly

For details on the backplate assembly, see section 3.3.1 on page 18.

*Note:* The backplate for this custom design has a mounting-hole pitch of 4.1 inches.



### 5.3.2 Spring Clip

The spring clip is designed to apply 75 lbs of force to the center of the heat sink. This force is necessary to help prevent the heat sink from lifting off of the package during shock or vibration-induced events. Lifting the heat sink away from the processor can result in damage to the processor contact pads, the socket contacts, or the socket solder-ball joints. Maintaining the spring force is important for the life of the processor and for repeated installations and upgrades of the processor.

The spring clip material is heat-treatable spring steel, SK7. AMD strongly recommends using SK7 or an equivalent material for the spring clip. The clip should be plated after heat treatment for cosmetic and anti-corrosive reasons. Table 9 gives the chemical composition of SK7. The heat treatment used should bring the ultimate strength of the material to a minimum of 1,300 megapascals (MPa) or 189 kilopounds per square inch (kpsi), and it should bring the yield strength to 940 MPa (or 136 kpsi). Other materials commonly used for heat sink spring clips have been shown to yield under the high load of the initial spring-clip deflection and become deformed so that the spring clip can no longer apply the same load.

**Table 9. Chemical Element of SK7 Spring Steel**

Element	Percentage of the Element
C	0.60-0.70
Si	Maximum 0.35
Mn	0.80-0.90
P	Maximum 0.030
S	Maximum 0.030
Fe	Remaining balance

### 5.3.3 Retention Frame

The plastic retention frame, made of 20% glass-filled Lexan, is a two-piece implementation rather than the single-piece frame used for socket 940. This change accommodates the larger foot-print of socket F (1207) processors.

The retention frame serves multiple purposes. The retention frame aligns the heat sink and provides a stop for the heat sink in large shock-force events. The retention frame and backplate are attached to the motherboard by the motherboard vendor. Two screws securely hold the backplate and retention frame together. The two mounting tabs on the retention frame serve as attachment points for the heat sink spring clip.

### 5.3.4 Heat Sink

Figure 10 on page 34 shows a picture of the reference design heat sink for 2U-4P systems. The footprint of the reference design heat sink is 92 mm x 58 mm. The heat sink weighs 378 g and has an aluminum fin stack soldered to the copper base. The copper base tapers from a thickness of 7 mm at

the center to 2.5 mm at the edges. The heat sink also has three heat pipes soldered to the base and connected to the top of the fin stack to improve fin efficiency. This design provides optimum heat spreading performance from the processor to the heat sink. The fin geometry has been designed to provide optimized thermal performance in combination with the fans, as described in Section 5.3.5, on page 35, in a typical 2U-4P system.

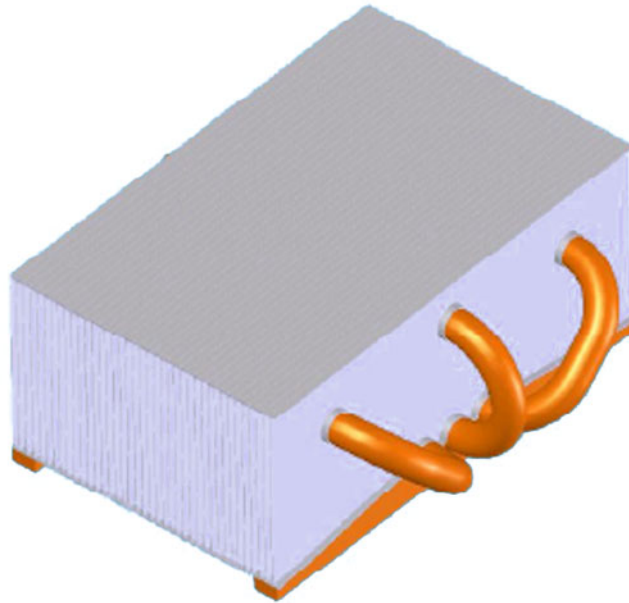

**Figure 10. High Performance Heat Sink for Custom 2U-4P Systems**

Table 10 shows the parameters of the aluminum fins for the high-performance heat sink shown in Figure 10.

**Table 10. Fin Parameters**

Length	Height (at Center)	Height (at Edges)	Thickness	Pitch	No of Fins
92 mm	32.5 mm	37 mm	0.2 mm	1.5 mm	39

Other fan and heat sink combinations may yield adequate thermal performance. The system designer must ensure that the thermal solution provides required cooling for the processor for the given system layout and flow characteristics.

Because the processor-mounting surface extends above the surface of the cam box on the socket, the heat sink bottom can be flat. The heat sink must have a flat surface of at least 40 mm x 40 mm, centered over the processor.

Figure 11 shows the measured thermal performance vs. flow rate for this heat sink. This data represents the expected performance of this heat sink on a dual-core socket F (1207) processor. Based

on flow simulations of an AMD reference 2U system, the flow-through of the heat sink is approximately 18 CFM. Figure 11 shows that this flow rate corresponds to a case-to-ambient thermal resistance of 0.22°C/W. This case-to-ambient thermal resistance exceeds requirements (see Table 7 on page 30).

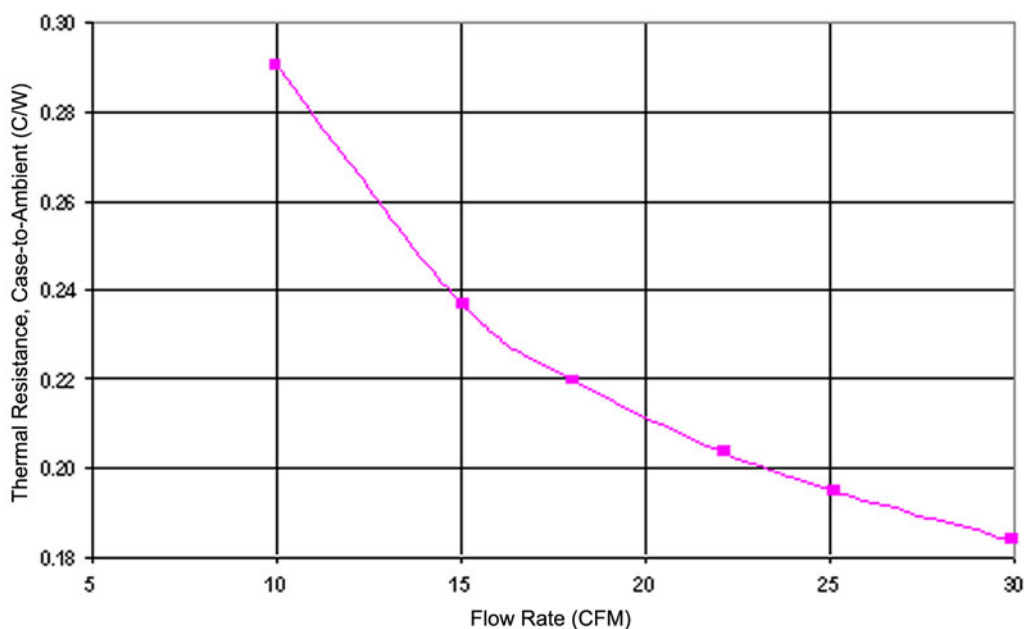

**Figure 11. Thermal Performance Chart of Heat Sink When Used with a Dual-Core Processor in 90 nm Process**

### 5.3.5 Fans

AMD has conducted simulations of the heat sink described in Section 5.3.4 on page 33 with two 60 mm x 60 mm x 38 mm fans (Delta Part number FFB0812EHE-HS2) in series, that is, back to back. The fans have a maximum flow rate of 80.2 CFM and a maximum pressure drop of 0.8 inches of water. The heat sinks are ducted so the flow from the two fans enters the processor heat sinks with some bypass. The bypass is designed to cool the core VRM.

### 5.3.6 Thermal Interface Material

The heat sink makes contact with the top surface of the processor package utilizing the thermal interface material between the processor lid and the heat sink. AMD recommends using a high performance grease such as Shin-Etsu 7783D or Dow Corning TC-5022. AMD does not recommend using phase change materials between the heat sink and the processor. Phase-change materials develop high adhesion forces between the heat sink and processor when the material is in the solid phase. This strong adhesive force may cause the processor to stick to the heat sink, making heat sink removal difficult and damaging the socket solder balls.



---

## **Appendix A      Keep-Out Drawings for Platforms Using the PIB Thermal Solution for Socket F (1207) Processors**

---

Appendix A contains detailed recommended keep-out drawings for processor heat sink and mounting hardware for platforms using socket F (1207) Processor-In-a-Box (PIB) processors. Depending on the system features and layout, more space around the processor may be available for the thermal solution than is shown in these drawings. This space permits the design of heat sinks with better thermal performance.

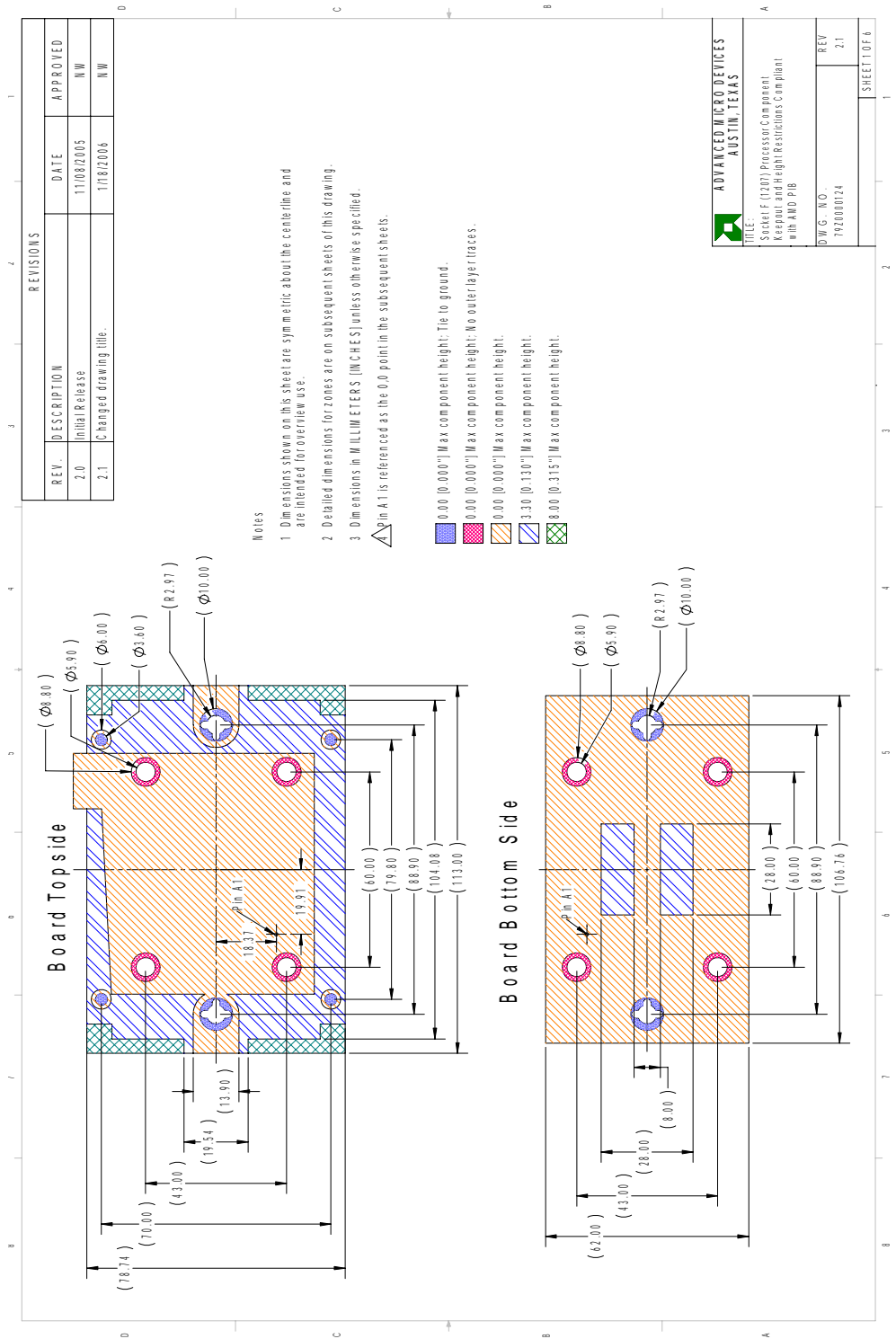

Figure 12. Socket F (1207) PIB Board Component Height Restrictions

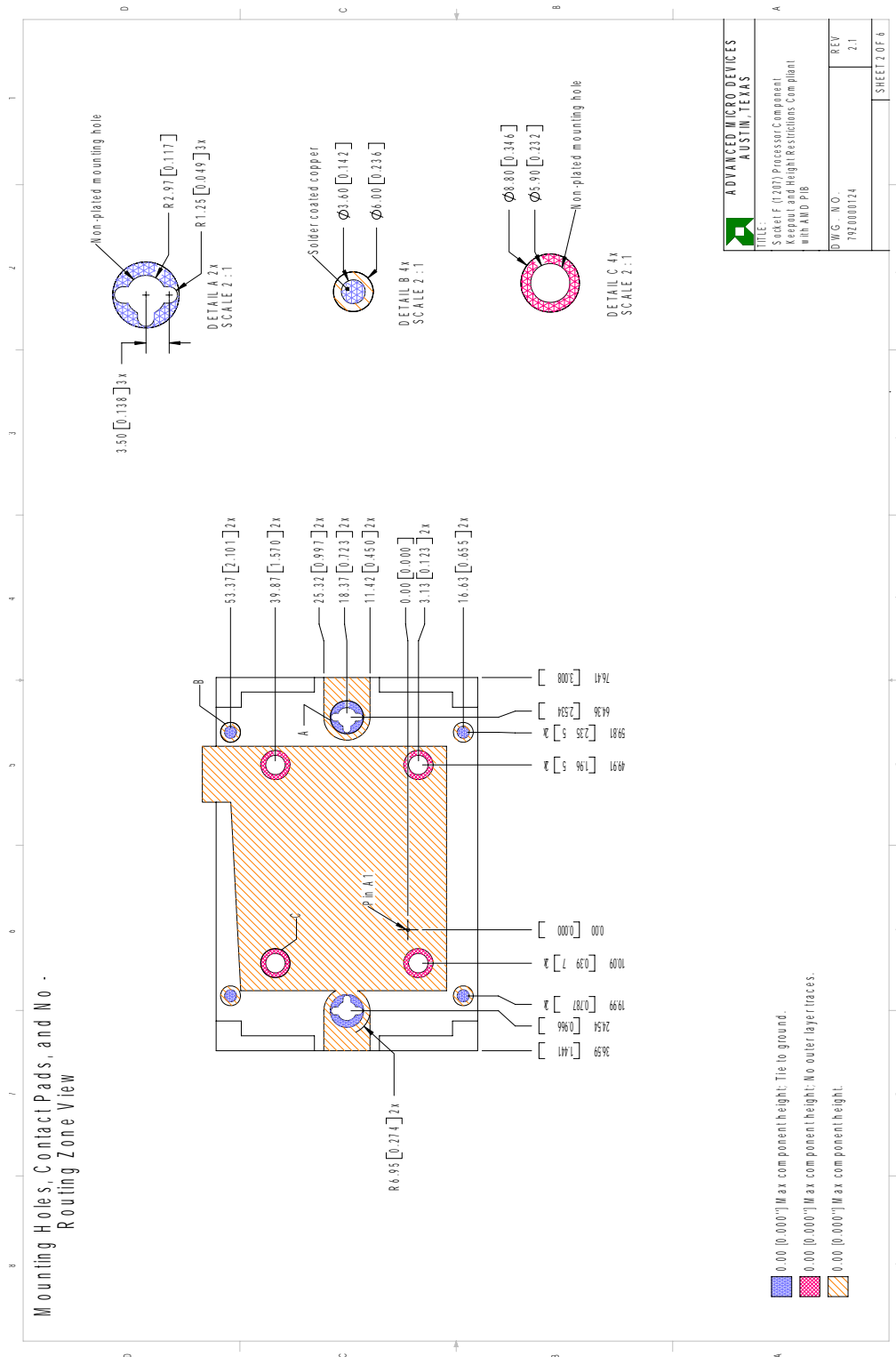

Figure 13. Socket F (1207) PIB Mounting Holes, Contact Pads, and No-Routing Zone

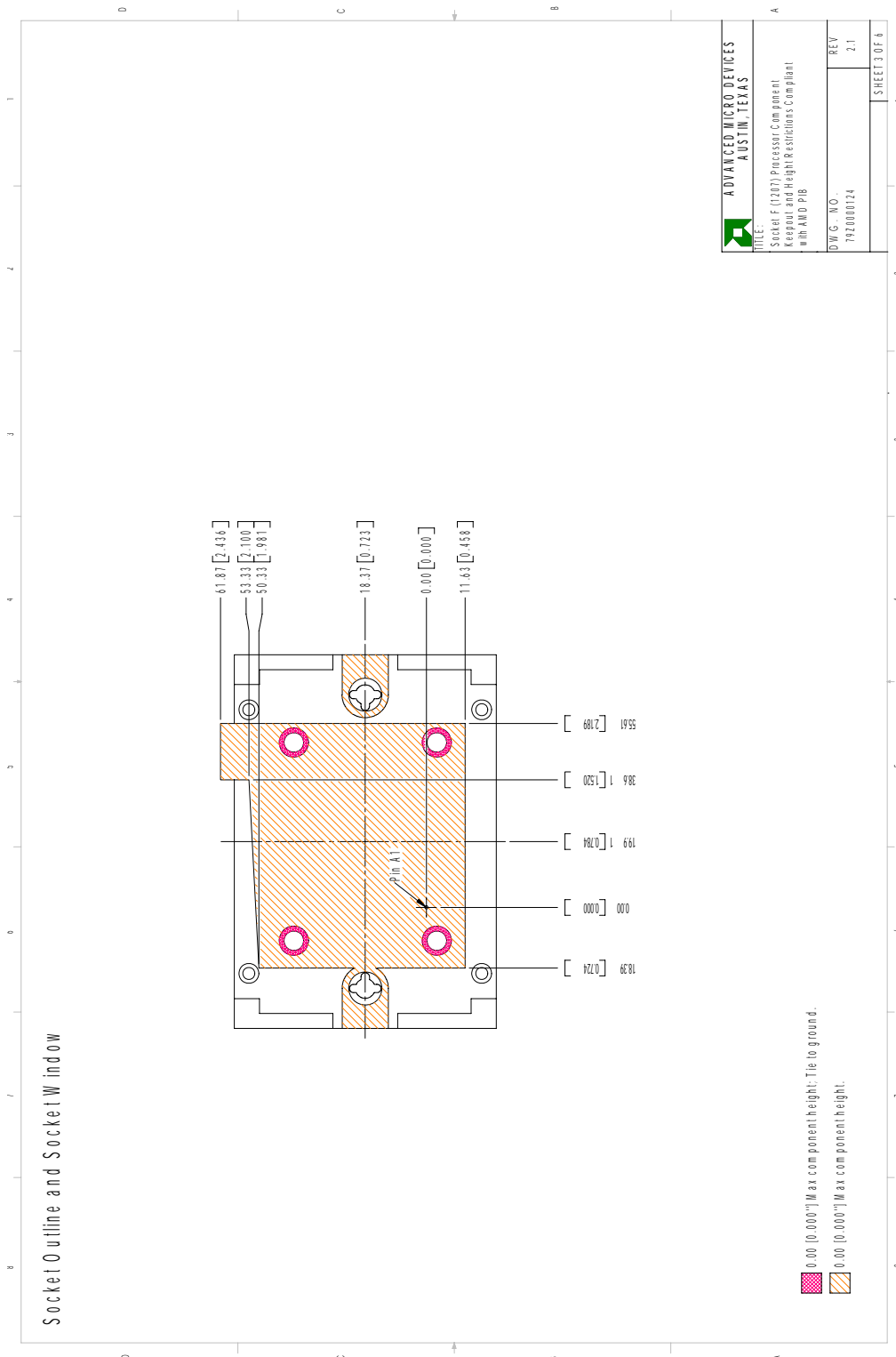

Figure 14. Socket F (1207) PIB Socket Outline and Socket Window



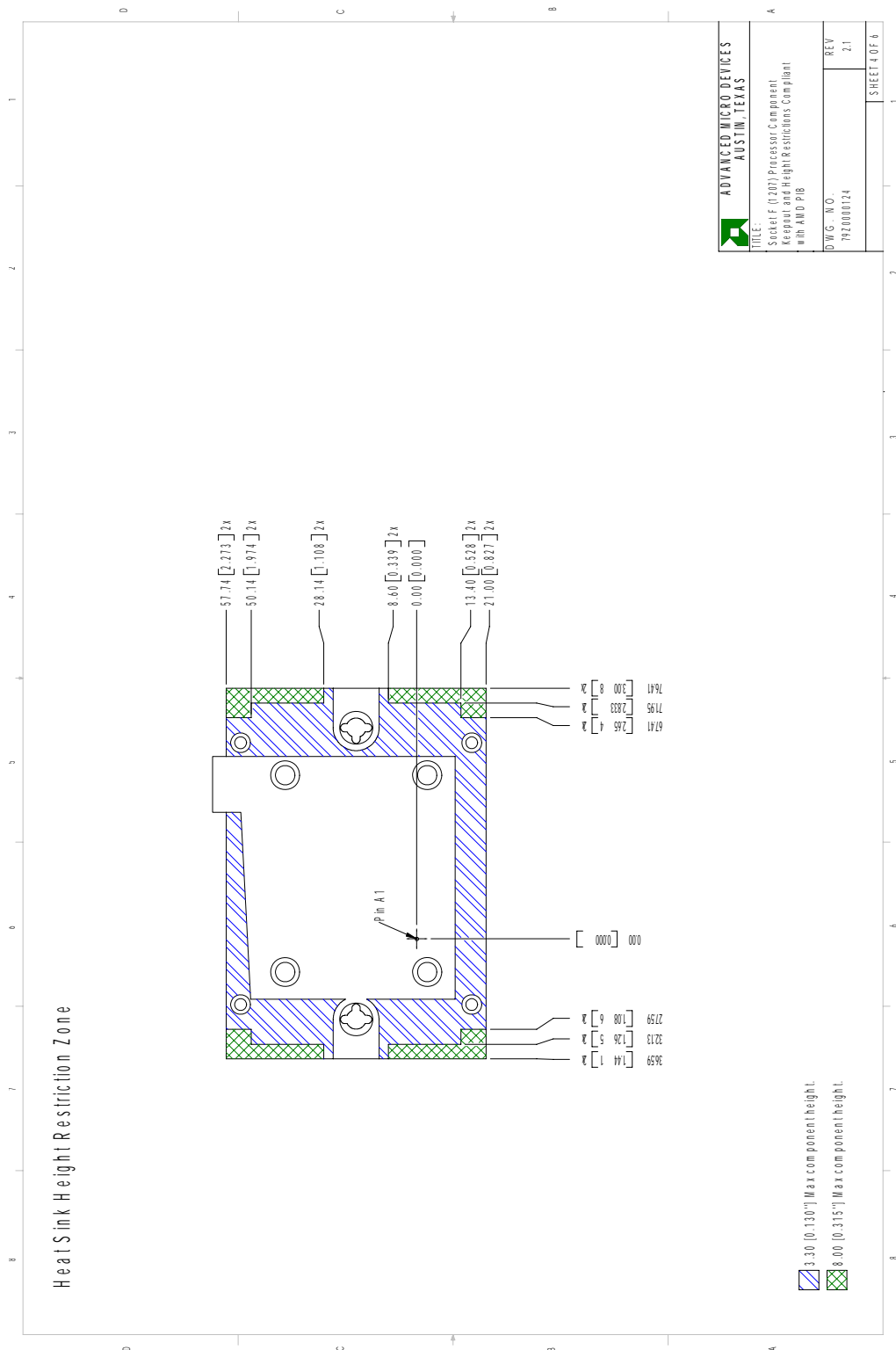

Figure 15. Socket F (1207) PIB Heat Sink Height Restriction Zone

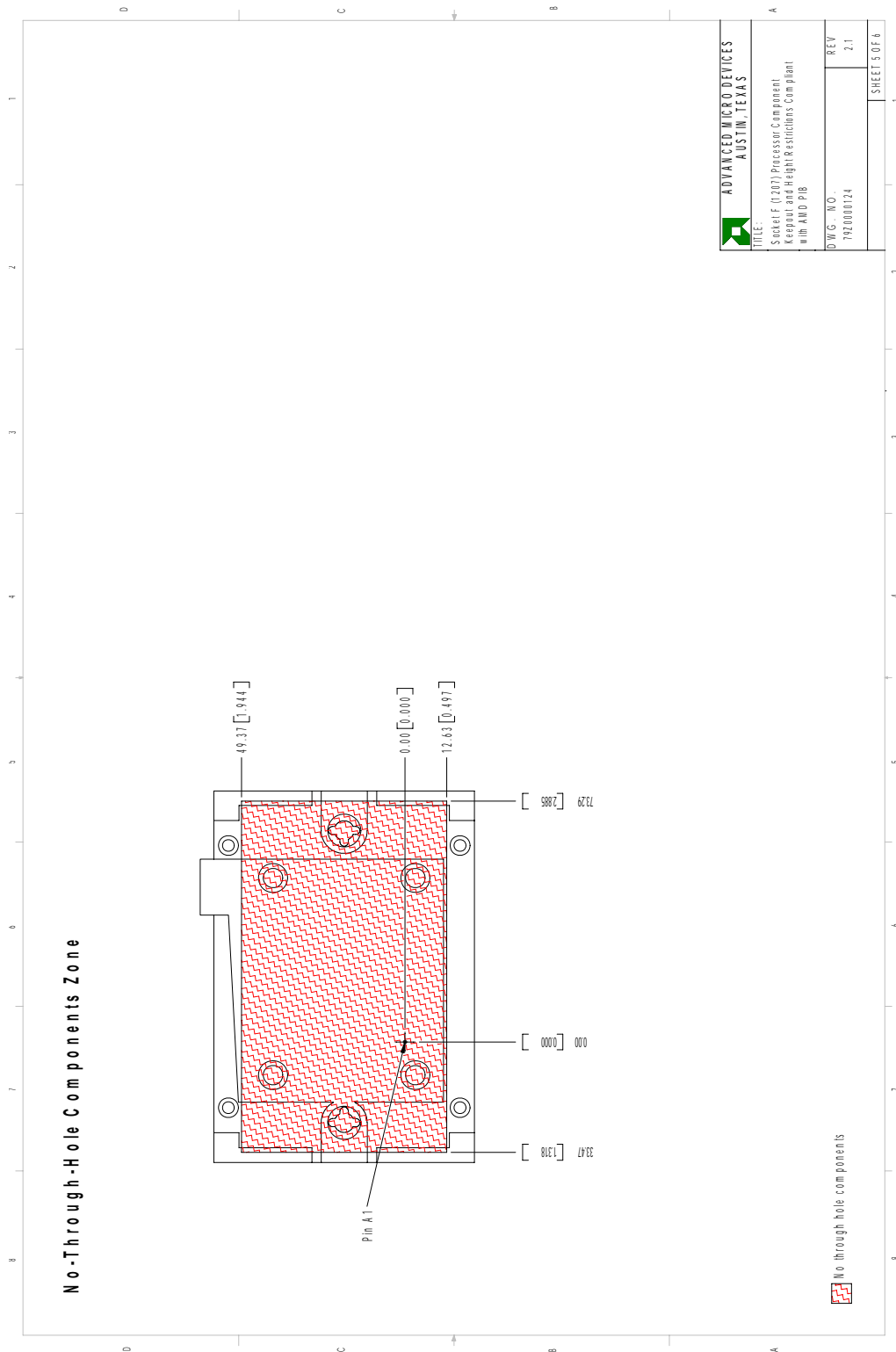

Figure 16. Socket F (1207) PIB Board No-Through-Hole Keep-Out

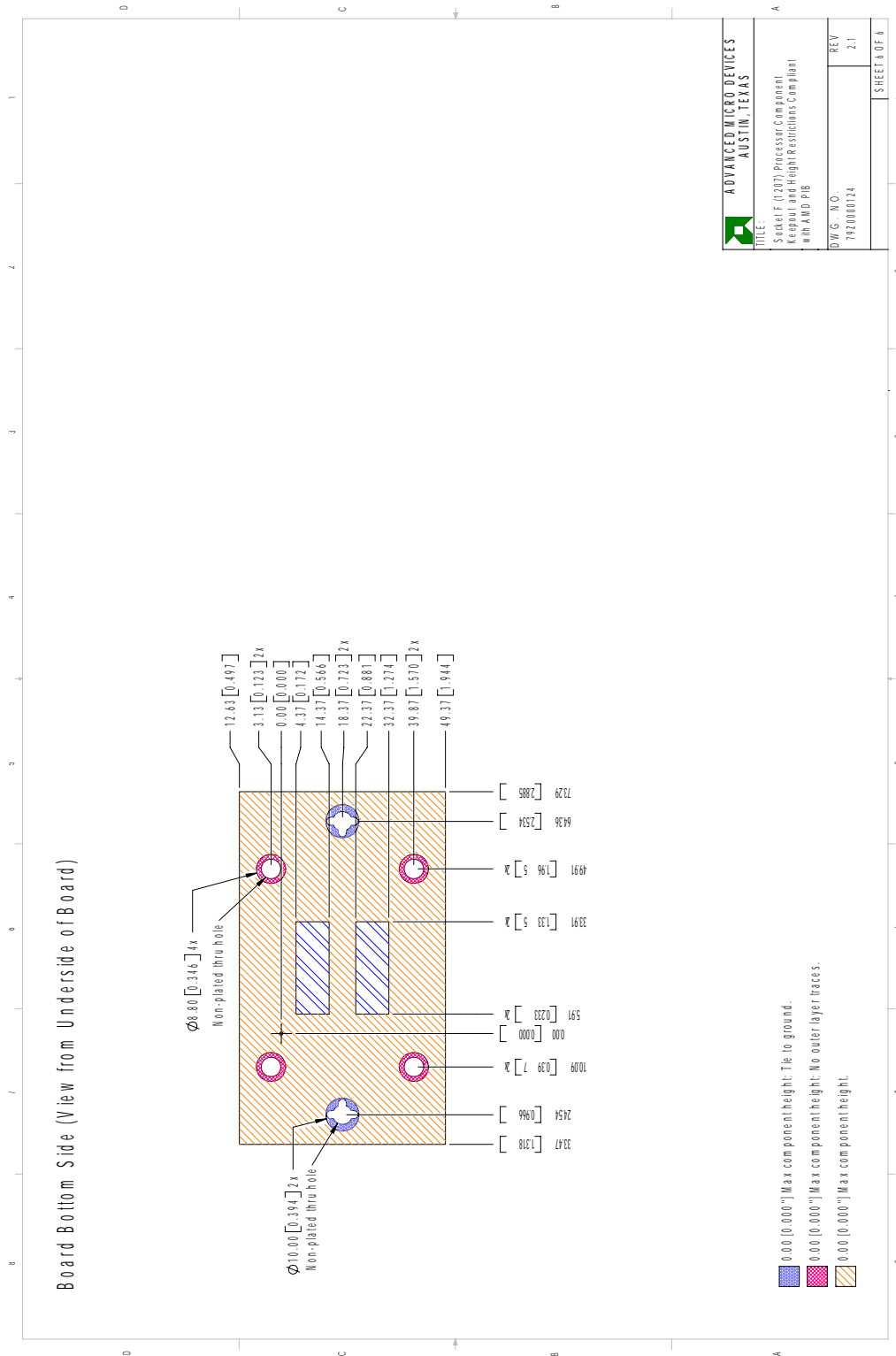

Figure 17. Socket F (1207) PIB Board Bottom Side Keep-Out



---

## Appendix B      **Keep-Out Drawings for Custom 1U-2P Systems Based on the Socket F (1207) Processor**

---

Appendix B contains detailed recommended keep-out drawings for processor heat sink and mounting hardware for a custom 1U-2P system based on the socket F (1207) processors. Depending on the system features and layout, more space around the processor may be available for the thermal solution than is shown in these drawings. This space permits the design of heat sinks with better thermal performance.

**Note:** *These keep-outs are defined for custom rack mount equipment to optimize thermal and acoustic performance in these systems. These keep-outs are not compliant with AMD Processor-In-a-Box (PIB) thermal solutions.*

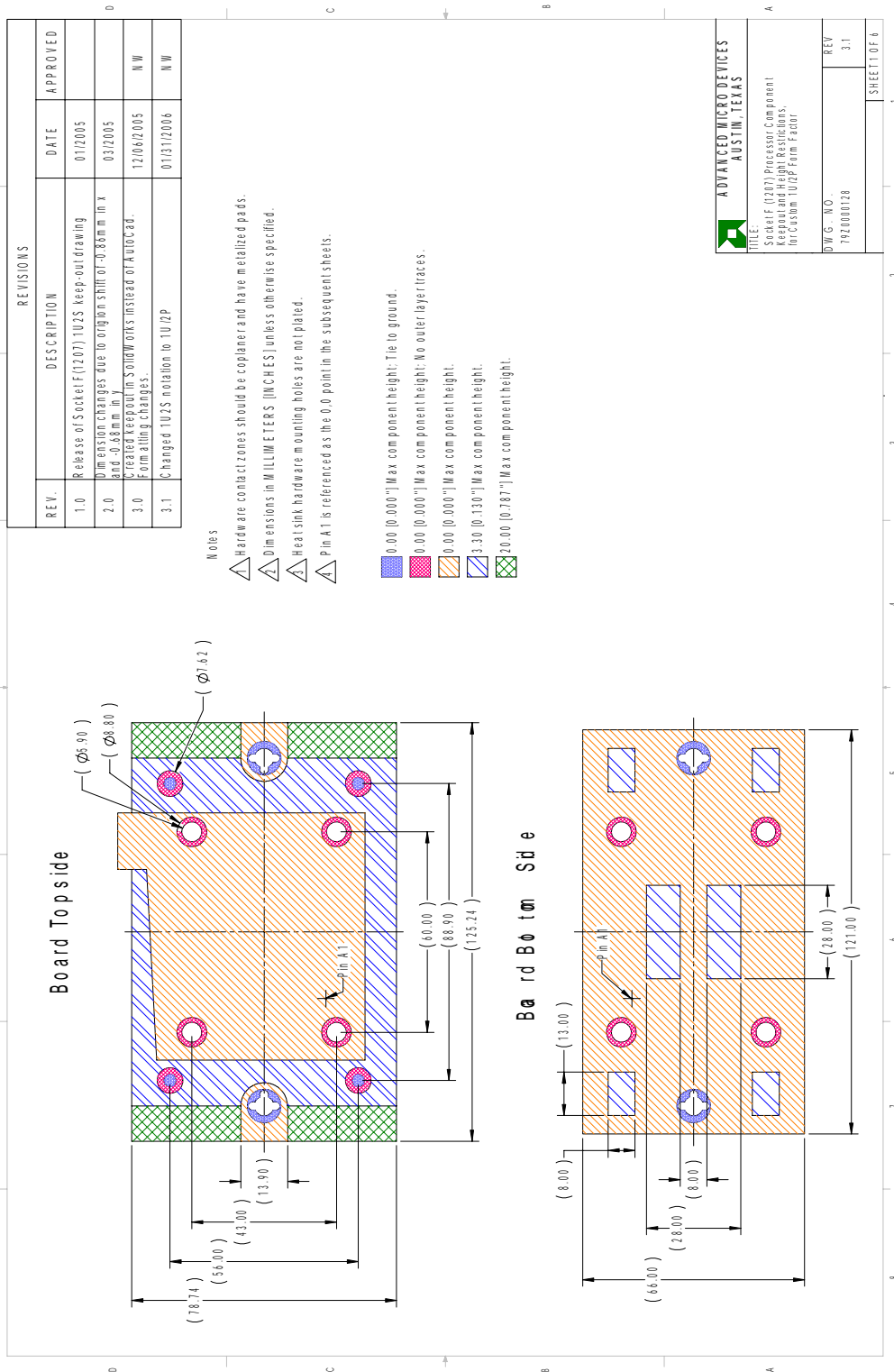

Figure 18. Socket F (1207) 1U-2P Board Component Height Restrictions

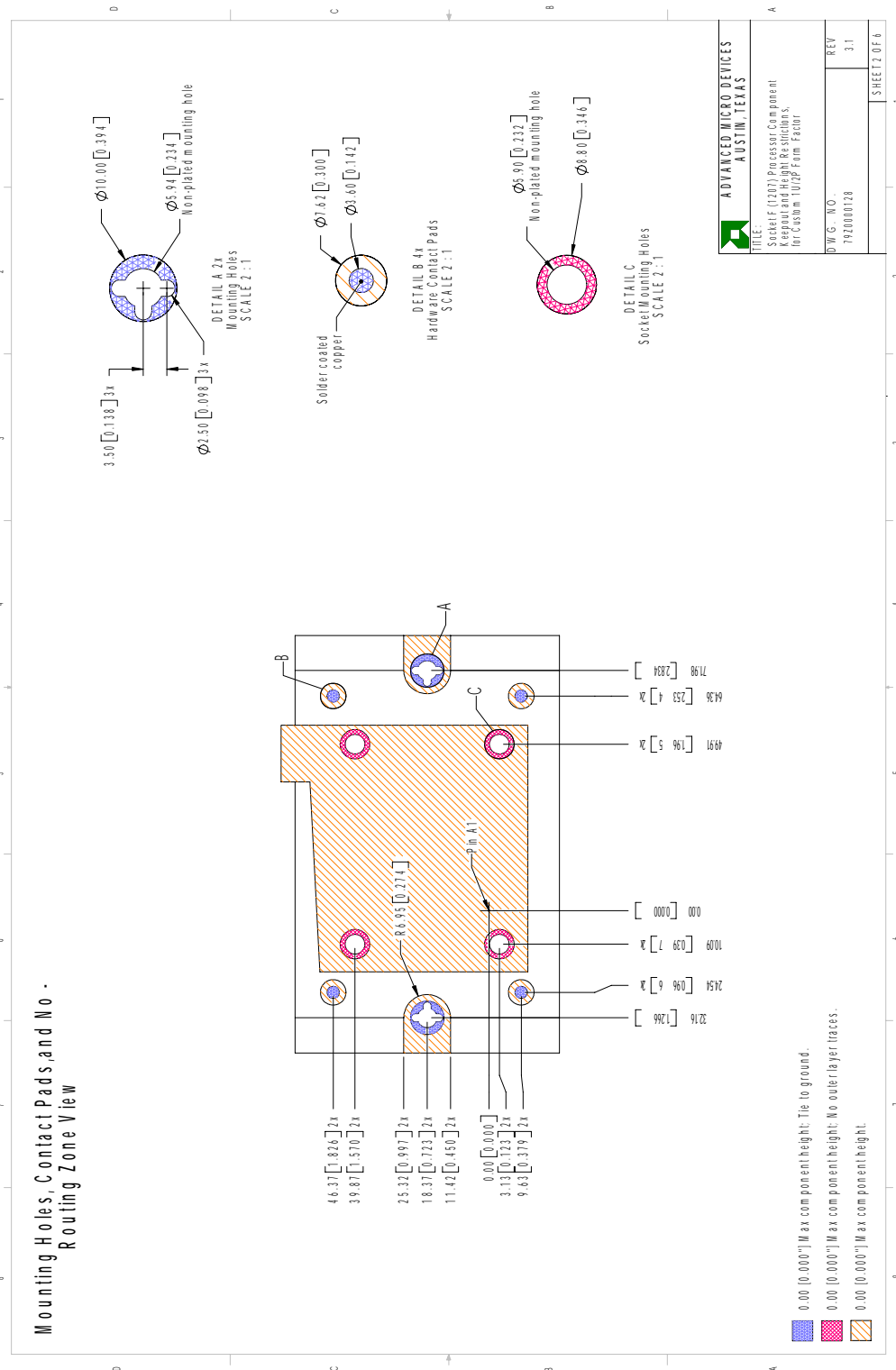

Figure 19. Socket F (1207) 1U-2P Mounting Holes, Contact Pads, and No-Routing Zone

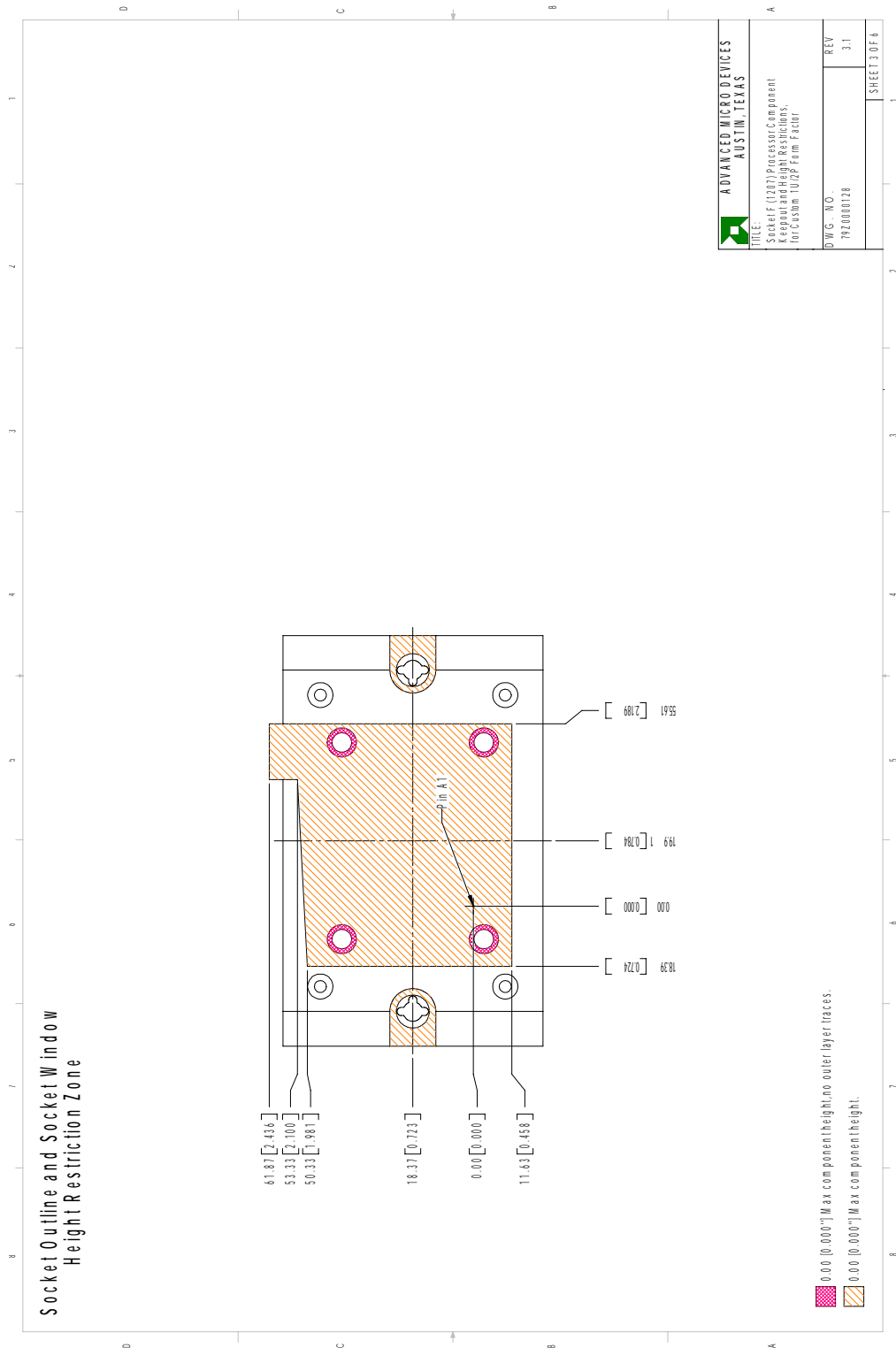

Figure 20. Socket F (1207) 1U-2P Socket Outline and Socket Window



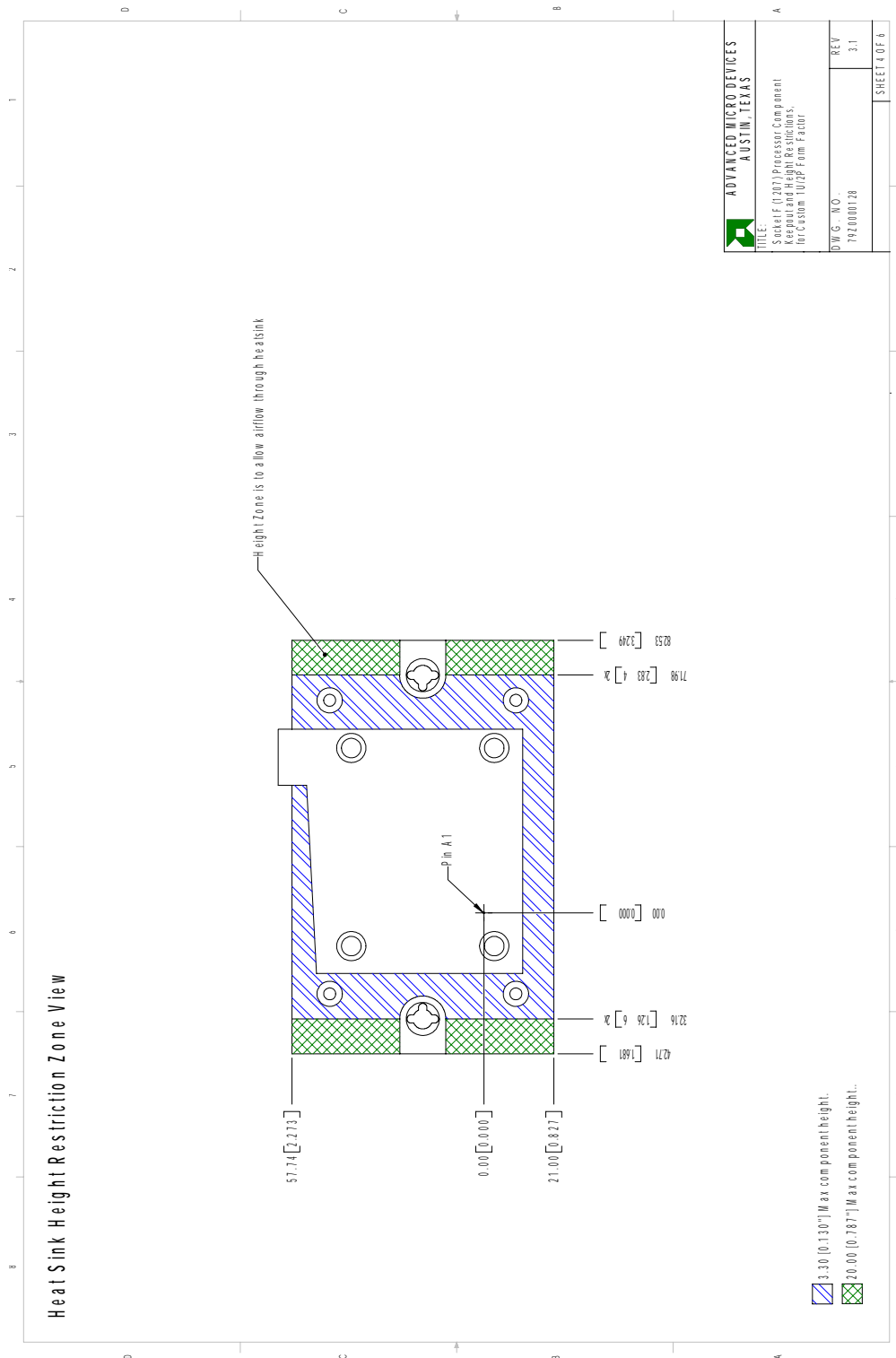

Figure 21. Socket F (1207) 1U-2P Heat Sink Height Restriction Zone

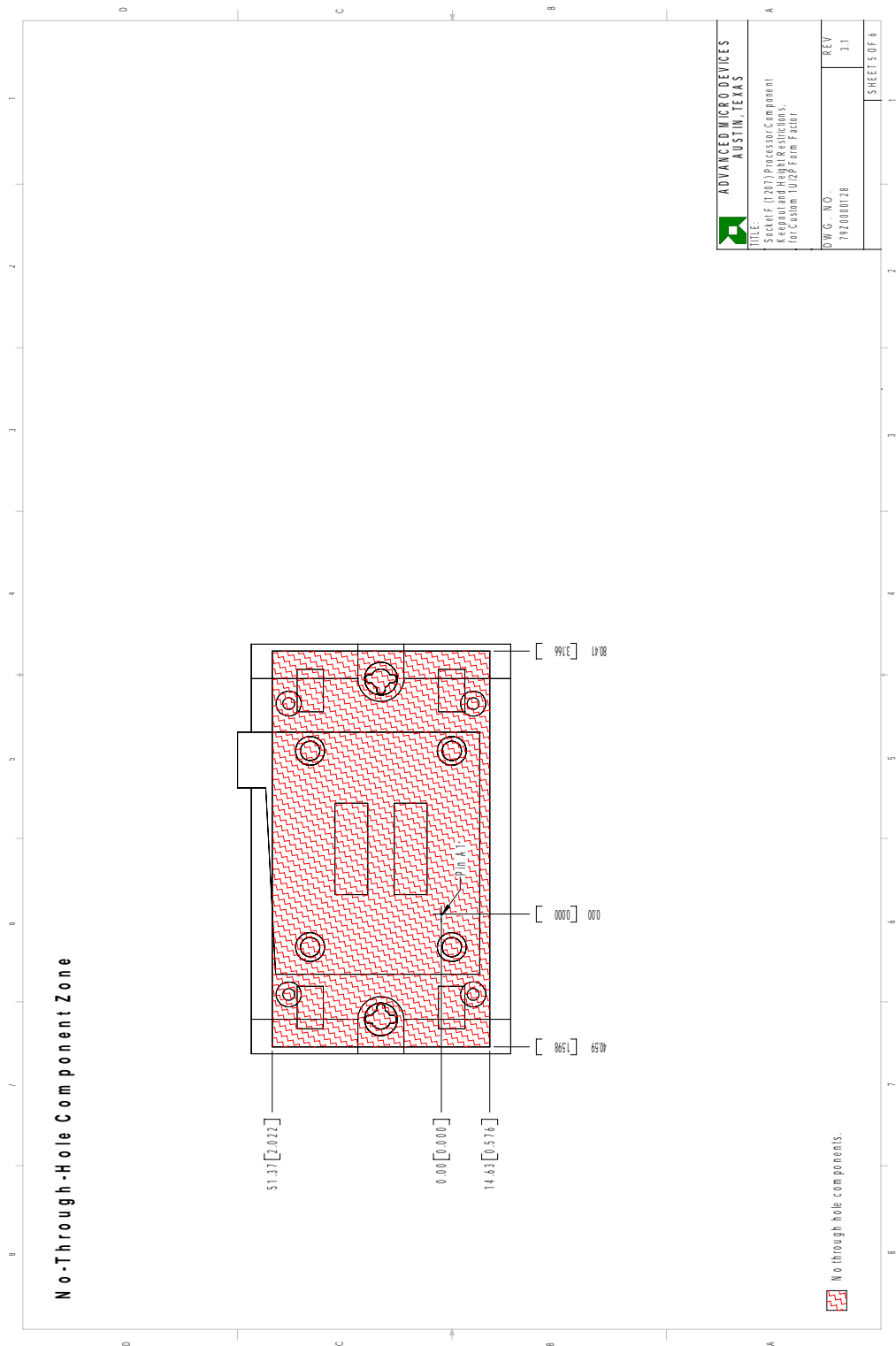
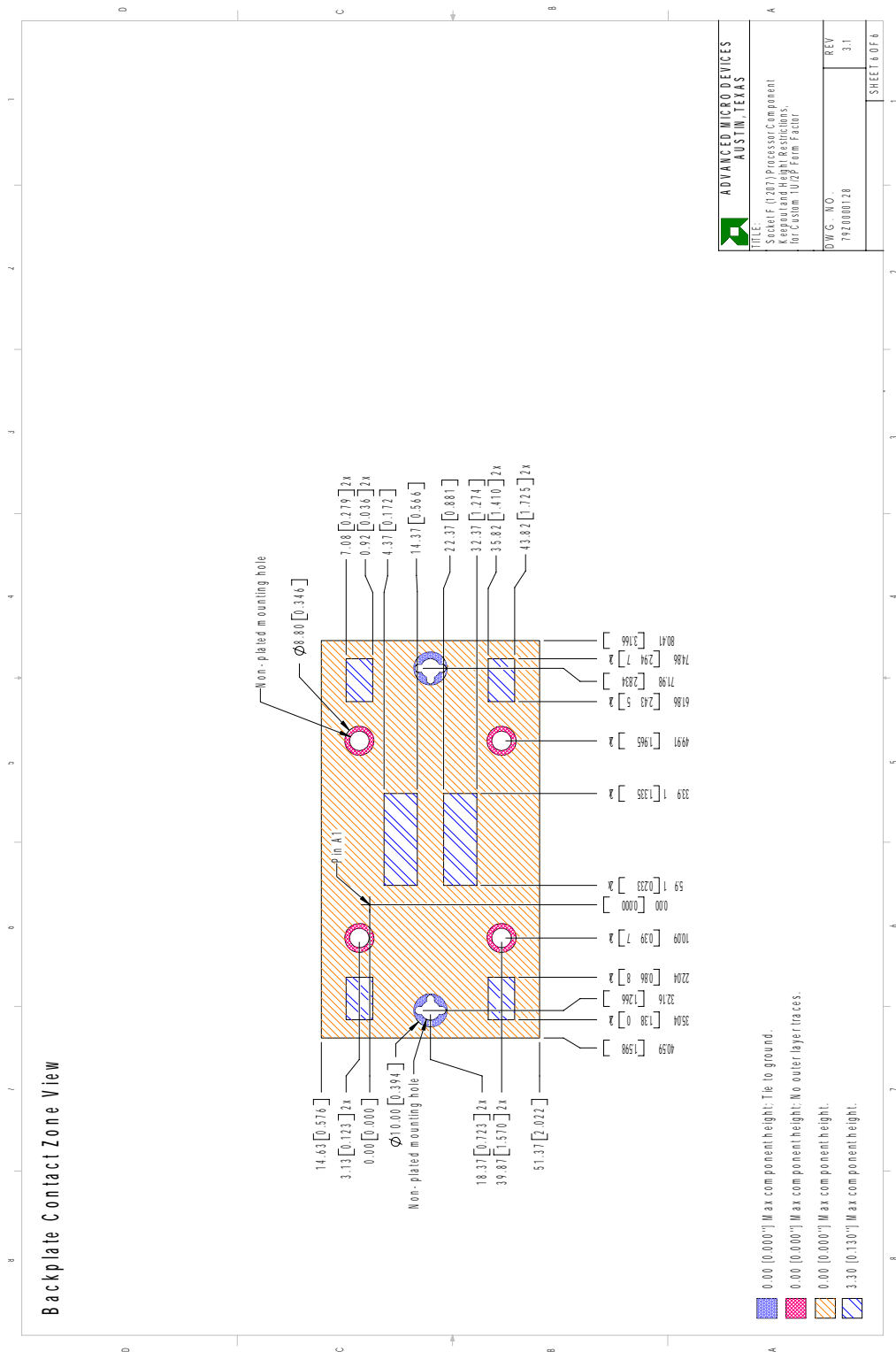

Figure 22. Socket F (1207) 1U-2P Board No-Through-Hole Keep-Out





---

## Appendix C      **Keep-Out Drawings for Custom 2U-4P Systems Based on the Socket F (1207) Processor**

---

Appendix C contains detailed recommended keep out drawings for processor heat sink and mounting hardware for a 2U-4P system based on the socket F (1207) processor. Depending on the system features and layout, more space around the processor may be available for the thermal solution than is shown in these drawings. This space permits the design of heat sinks with better thermal performance.

**Note:** *These keep-outs are defined for custom rack mount equipment to optimize thermal and acoustic performance in these systems. These keep-outs are not compliant with AMD Processor-In-a-Box (PIB) thermal solutions.*

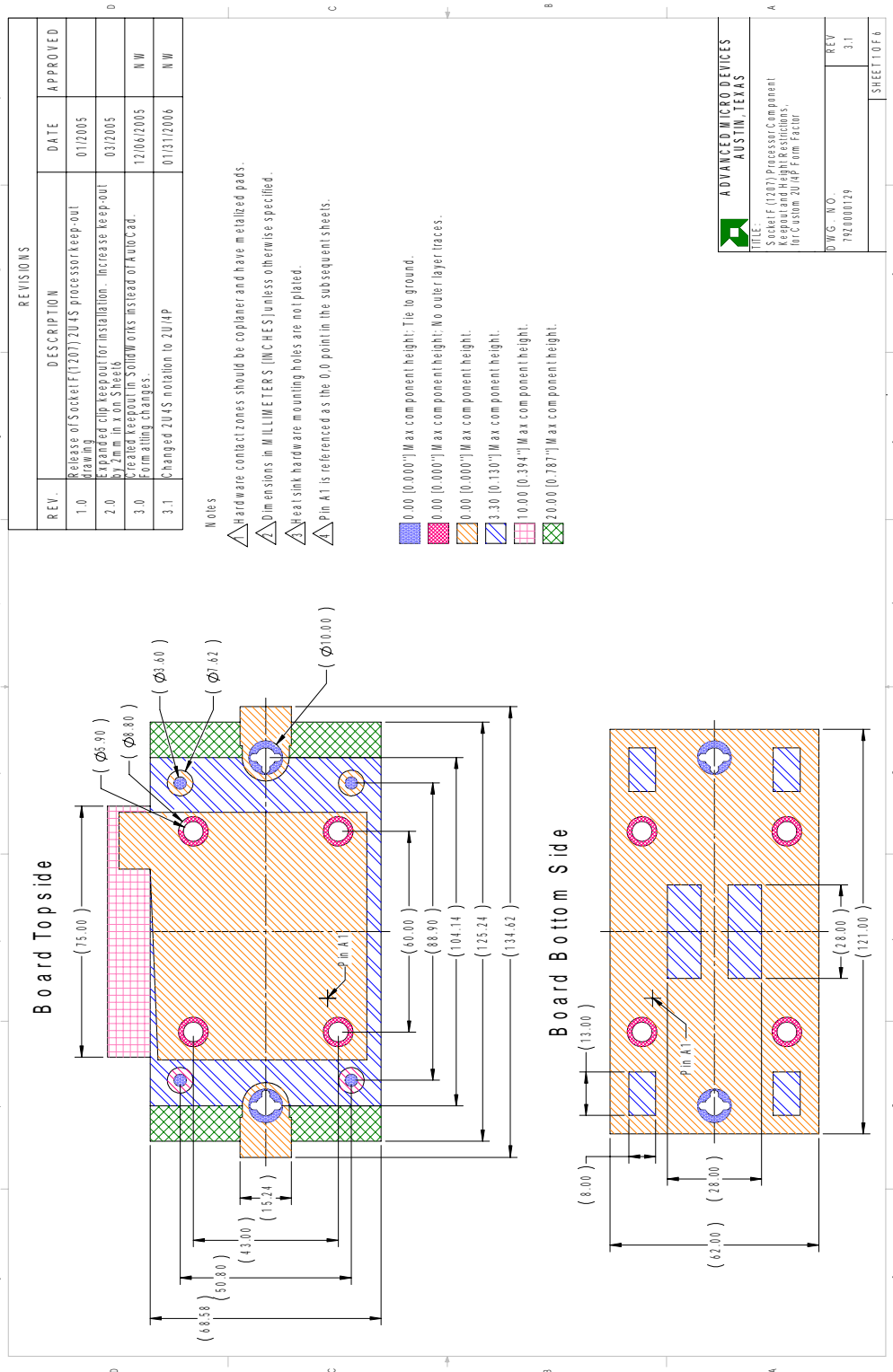

Figure 24. Socket F (1207) 2U-4P Board Component Height Restrictions

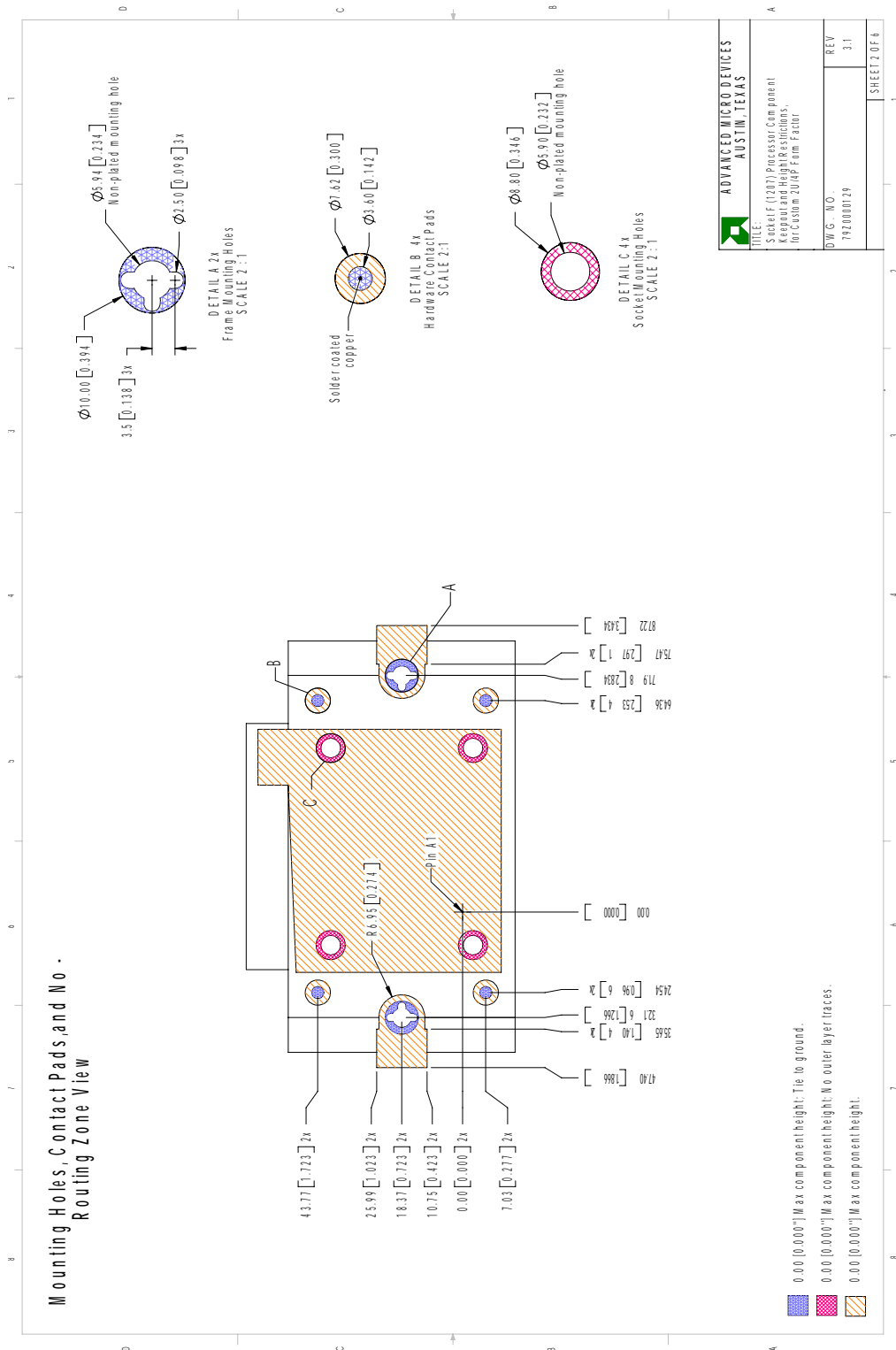

Figure 25. Socket F (1207) 2U-4P Mounting Holes, Contact Pads, and No-Routing Zone

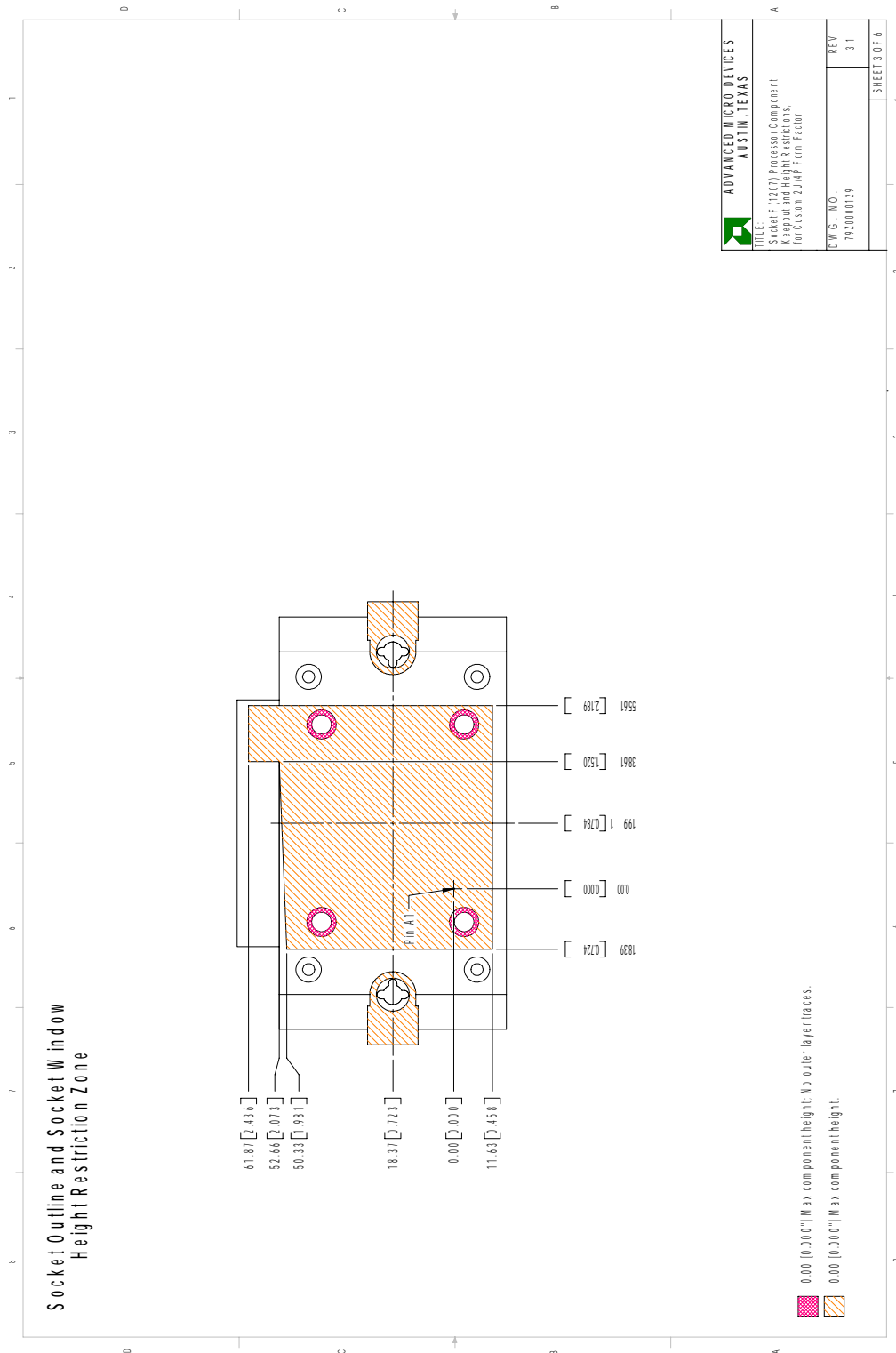

Figure 26. Socket F (1207) 2U-4P Socket Outline and Socket Window



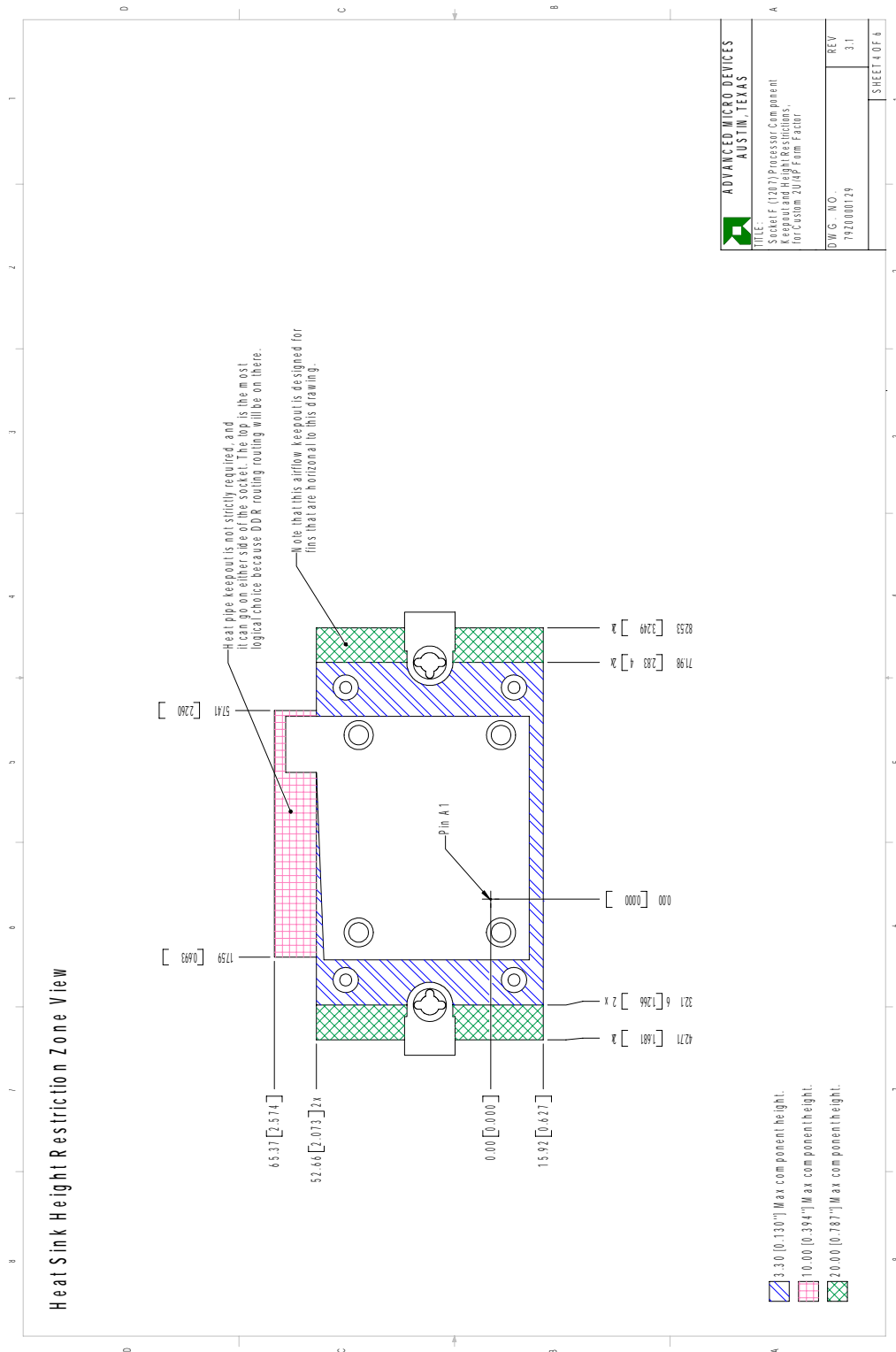

Figure 27. Socket F (1207) 2U-4P Heat Sink Height Restriction Zone

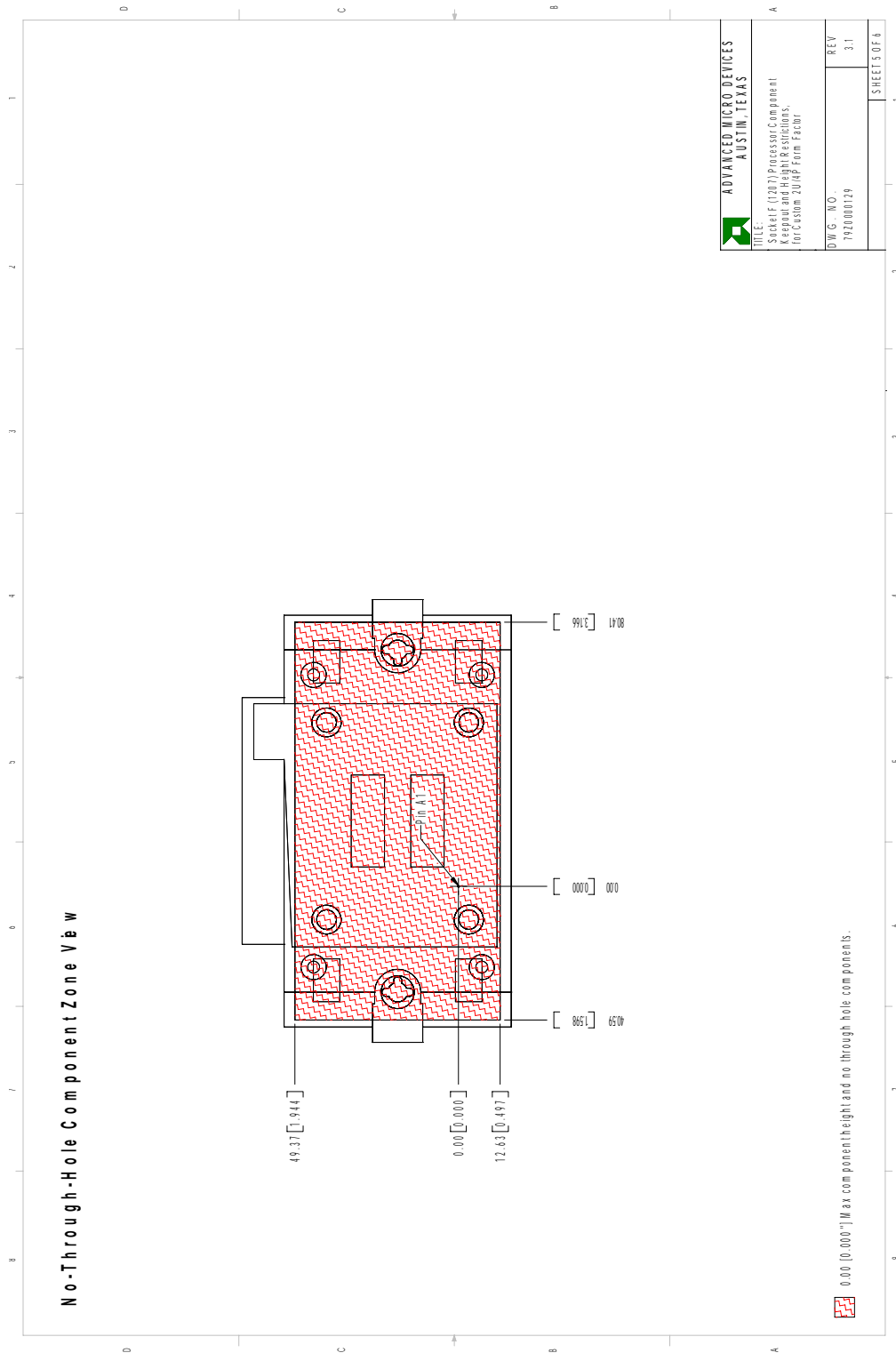

Figure 28. Socket F (1207) 2U-4P Board No-Through-Hole Keep-Out

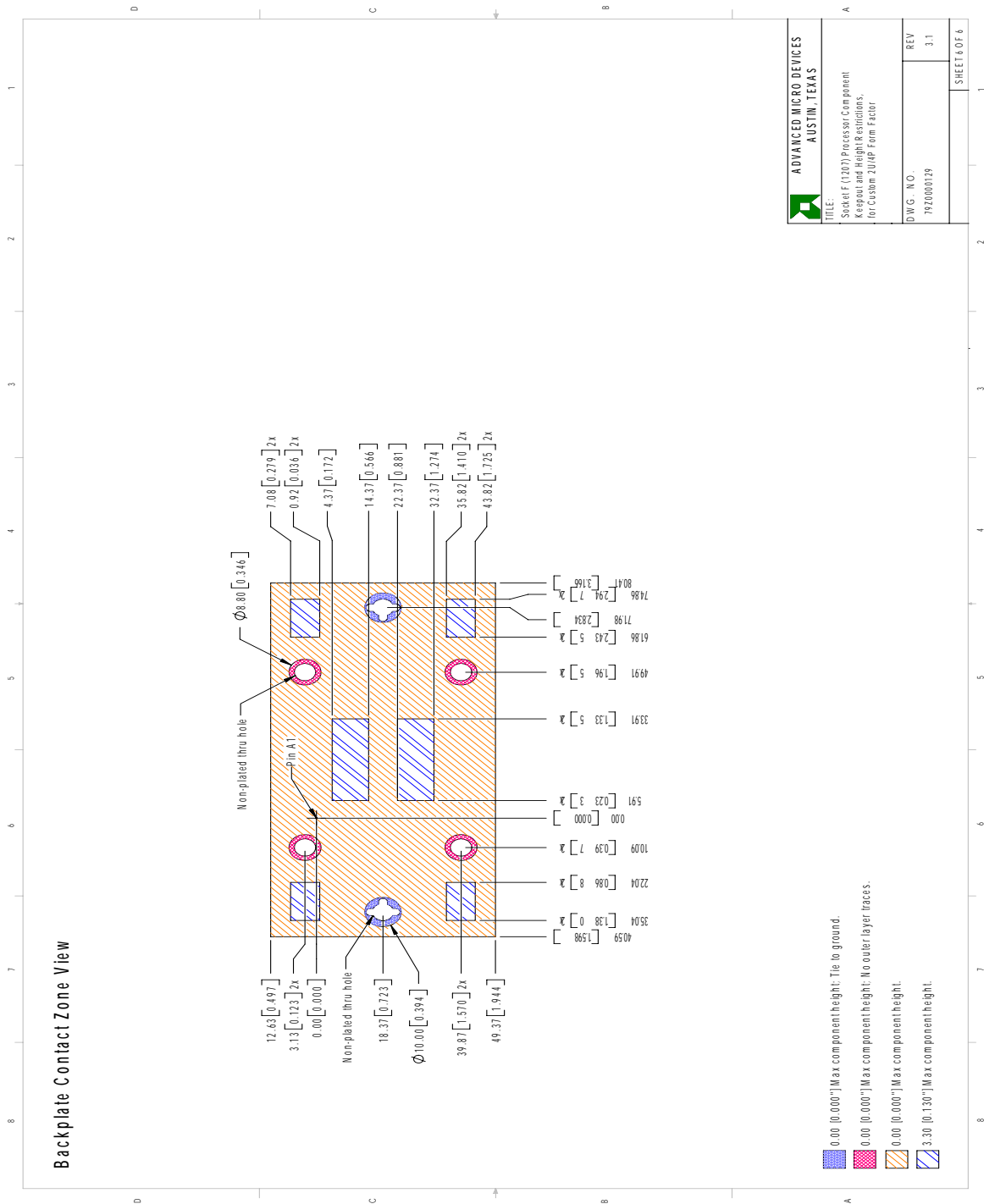

Figure 29. Socket F (1207) 2U-4P Backplate Contact Zone



## Appendix D Flow Simulation Results for Custom 2U-4P Systems Based on Socket F (1207) Processors

Appendix D describes the flow simulation results for 2U-4P systems based on socket F (1207) processors.

Figure 30 shows a floor plan of an AMD reference custom 2U-4P system.

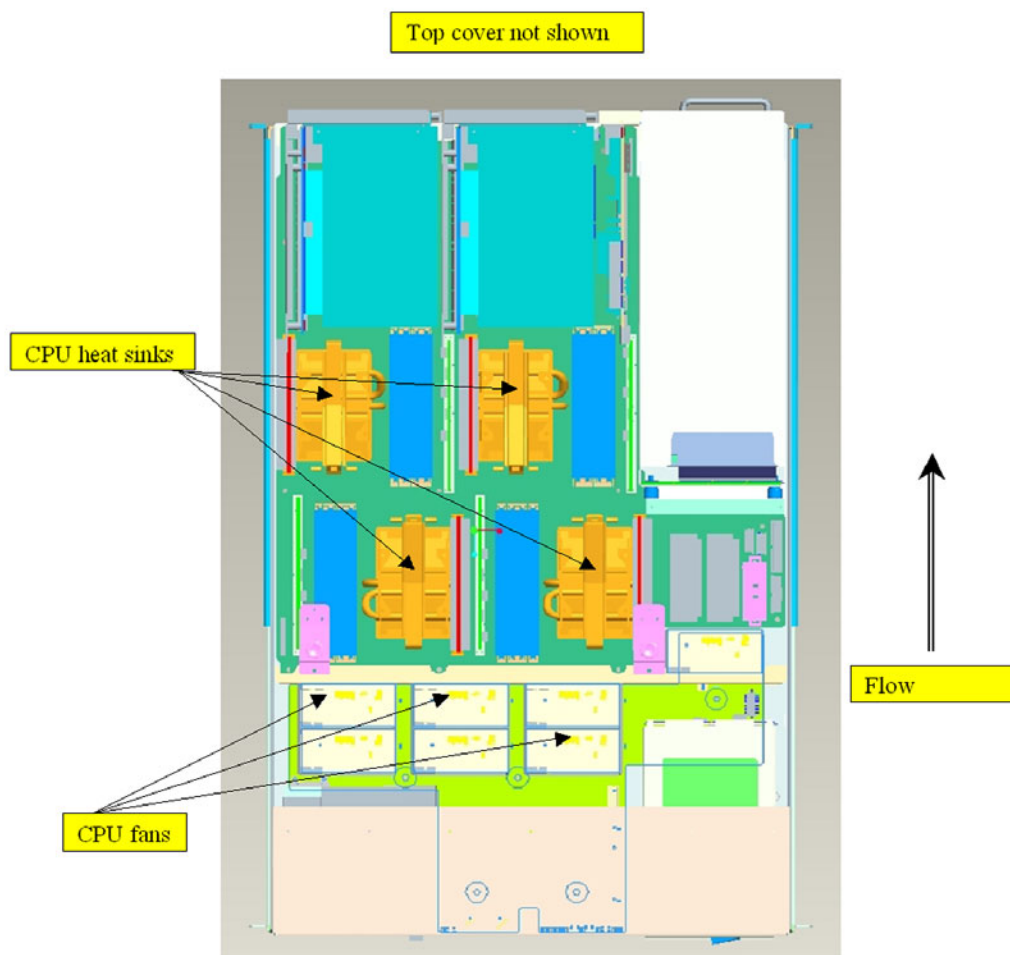

**Figure 30. Floor-Plan of AMD Reference Custom 2U-4P System**

Figure 31 shows a streamline plot of an AMD reference 2U-4P system.

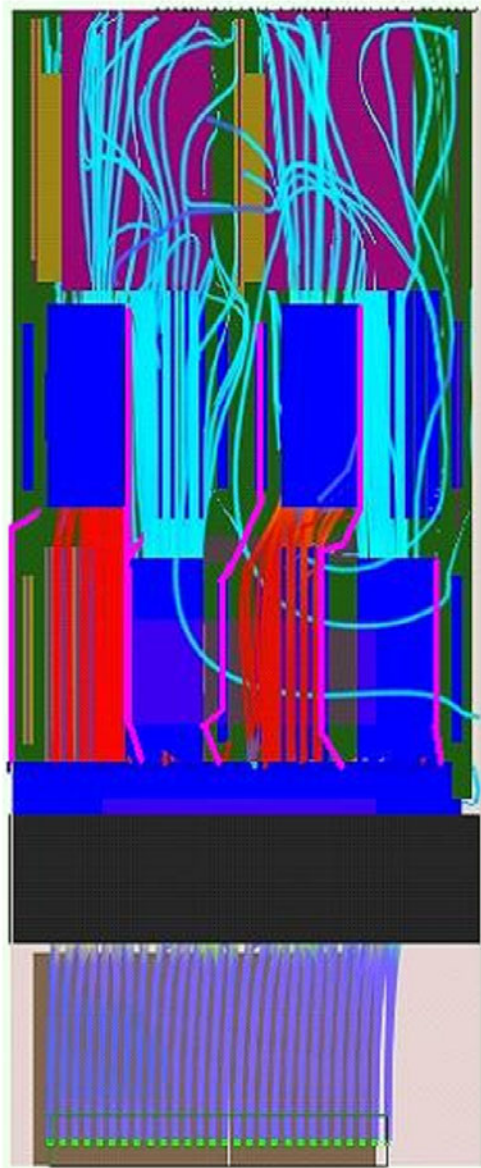

**Figure 31. Streamline Plot of AMD Reference Custom 2U-4P System**

Thermal simulation of the 2U-4P system shown in Figure 30 on page 61 with the heat sink and fan described in Chapter 5 on page 29 predicts a flow rate through the heat sink of approximately 18 CFM and an air inlet temperature at the processor heat sinks of 3°C above external ambient temperature.